

**Honeywell**

# **LYNX Touch L5200 Series Security System**

***User Guide***

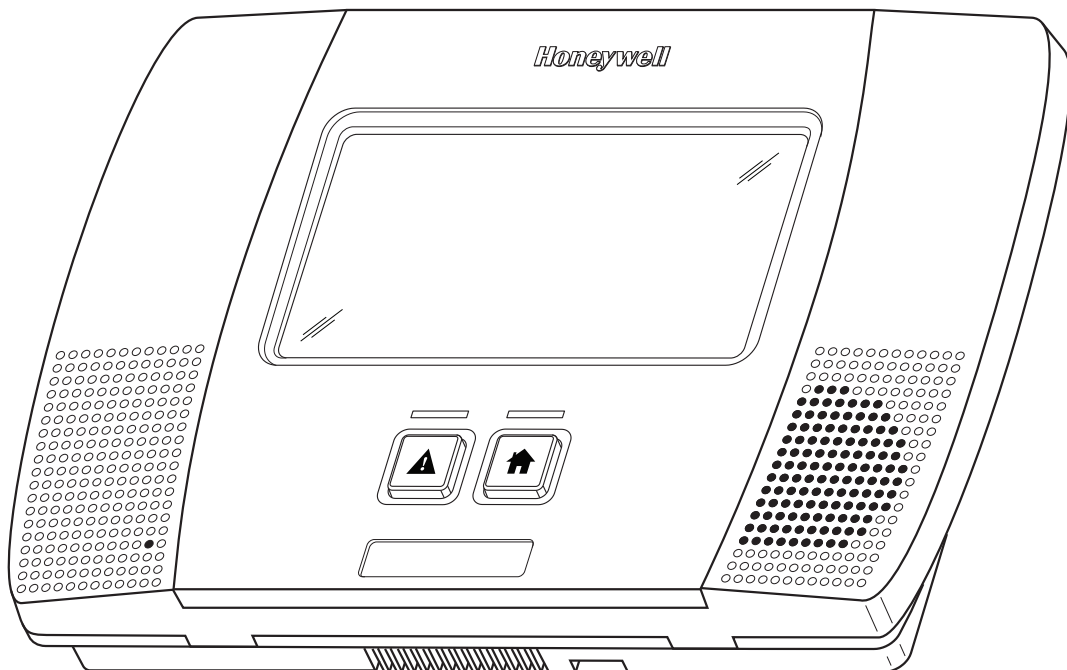

Your Honeywell security system is designed for use with devices manufactured or approved by Honeywell for use with your security system. Your Honeywell security system is not designed for use with any device that may be attached to your security system's control or other communicating bus if Honeywell has not approved such device for use with your security system. Use of any such unauthorized device may cause damage or compromise the performance of your security system and affect the validity of your Honeywell limited warranty. When you purchase devices that have been manufactured or approved by Honeywell, you acquire the assurance that these devices have been thoroughly tested to ensure optimum performance when used with your Honeywell security system.

# TABLE OF CONTENTS

<b>SYSTEM OVERVIEW</b> .....	5
Features .....	5
General Operation.....	7
Quick View of System Functions.....	8
About the Touch screen Control.....	10
About the Display and Indicators .....	11
Navigating Menus .....	13
<b>SECURING THE PREMISES</b> .....	16
System Status.....	16
Arming the System.....	17
Entry/Exit Delays.....	24
Disarming the System.....	26
Bypassing Protection Zones.....	28
Panic Keys .....	30
Chime Mode.....	31
Voice Mode.....	32
<b>USER FUNCTIONS</b> .....	33
User Access .....	33
View Events .....	37
Message Recording and Playback .....	38
System Settings.....	40
Clock/Calendar .....	41
Automation .....	44
Reminders .....	51
WiFi Configuration.....	54
Video Camera Control Feature .....	57
Speaker Phone Feature.....	60
Remote Phone Control Feature .....	62
Two Way Voice Feature (Alarm Audio Verification).....	63
Remote Services.....	64
Slide Show.....	65
<b>SUMMARY OF AUDIBLE &amp; VISUAL NOTIFICATIONS</b> .....	66
Audible Soundings.....	66
System Displays .....	67
<b>SYSTEM FUNCTIONS</b> .....	68
Testing the System.....	68
Maintaining Your System.....	70
<b>FIRE/CO ALARM SYSTEM</b> .....	72
General Information.....	72
National Fire Protection Association’s Smoke Detector Recommendations .....	73
Emergency Evacuation .....	74
<b>REGULATORY AGENCY STATEMENTS</b> .....	75
<b>SERVICING INFORMATION</b> .....	76
<b>OWNER’S INSURANCE PREMIUM CREDIT REQUEST</b> .....	77
<b>LIMITATIONS OF THIS ALARM SYSTEM</b> .....	79
<b>INDEX</b> .....	86
<b>TWO YEAR LIMITED WARRANTY</b> .....	88

---

*Congratulations on your ownership of a Honeywell Security System. You have made a wise decision in choosing it, for it represents the latest in security protection technology today. Honeywell is the world's largest manufacturer of security systems and millions of premises are protected by Honeywell products.*



### General Information

This system offers you three forms of protection: burglary, fire, and emergency, depending on the configuration of your system. The system consists of a touch screen control for system operation, various wireless sensors that provide perimeter and interior burglary protection, and optional smoke or combustion detectors to provide early fire warning. In addition, optional wireless keypads or key fobs may have been installed to allow you to control the system away from the touch screen control. The system may also be used as a speaker phone.

The system monitors protection zones and system status, displays appropriate information on the touch screen display, and initiates appropriate alarms. Your system may also have been programmed to automatically send alarm or status messages over the phone lines or via the cellular/GSM network or the internet to a central alarm monitoring station, and may also be capable of two-way voice communication with the central station.

#### IMPORTANT SECURITY NOTICE

Your key fob is similar to your keys or access card. If lost or stolen, another person can compromise your security system. Immediately notify your Dealer/Installer of a lost or stolen key fob. The Dealer/Installer will then remove the key fob programming from the security system.

The user features of this security system are listed below. Ask your installer which features have been programmed for your system.

- **Stay and Away arming modes:** By using these modes you can protect either the perimeter only, or the entire premises.
- **Panic key functions:** A designated key allow you to manually activate fire, medical emergency, or silent police alarms. Refer to the *Panic Keys* section for detailed information.
- **Follow me reminder announcements:** Allows the panel to dial a number that you have specified, at a programmed day/time and deliver a message programmed by your installer.
- **Real-time clock:** Touch screen displays current date and time. Refer to the *Clock/Calendar* section for procedures for setting the time.
- **Message center:** The system allows recording and play back of brief voice messages. Refer to the *Recording/Playback Messages* section for procedures.
- **Two-way voice:** Allows the central station to listen, talk to or conduct two-way conversations with individuals on the premises
- **Phone Control:** Provides a remote interactive phone capability that permits access to the security system from any off-site touch-tone telephone. Refer to the *Remote Phone Control Feature* section for detailed information.
- **Speaker Phone:** The system is capable of operating as a speaker phone allowing hands free telephone conversation. Refer to the *Speaker Phone Feature* section for detailed information.
- **Security Codes:** The system is capable of supporting an Installer code, Master user code and 30 additional User codes including Guest and Duress codes. Refer to the *User Access* section for detailed information.
- **Device activation:** Allows you to send "Follow-Me" messages, as a result of a system event such as an alarm or trouble condition. Refer to the *Automation* section for detailed information.
- **Schedules feature:** Allows you to schedule the automatic activation or deactivation of program events (e.g. alarm clock, reminder, and latch key). Refer to the *Automation* section for detailed information.
- **Notices** (Requires TotalConnect Service): Provides access to Dealer Notification Messages.
- **Web content** (Requires TotalConnect Service): The system allows you to view and display web content including Weather, News and Traffic reports.
- **Video Camera Control:** (Requires a WiFi communications device and a router) The system supports video cameras and allows selection, control and viewing of video from a single camera.

### Zones

- Your system's sensing devices have been assigned to various "zones." For example, the sensing device on your entry/exit door may have been assigned to zone 01, sensing devices on windows in the master bedroom to zone 02, and so on. These numbers appear on the display when an alarm or trouble condition occurs.

# SYSTEM OVERVIEW

---

## Features

### Fire Protection

The fire protection portion of your security system (if used) is always active and will sound an alarm if a fire condition is detected. Refer to the *Fire Alarm System* section for important information concerning fire protection, smoke detectors and planning emergency exit routes from the premises.

### Carbon Monoxide

The carbon monoxide (CO) portion of your security system (if used) is always active and will sound an alarm if a CO condition is detected. Refer to the *Fire Alarm System* section for more information.

### Burglary Protection

Your system provides two modes of burglary protection: STAY and AWAY. STAY mode protects the perimeter only, allowing you to freely move inside the premises. AWAY mode protects the entire system. Both modes provide an entry delay time that allows you to reenter the premises without setting off an alarm. For additional security, you can turn the entry delay off when arming the system. Refer to the *Arming the System* section. The system also allows you to bypass selected zones before arming the system, if desired. Refer to the *Bypassing Protection Zones* section. The system also provides a Chime mode, for alerting users to the opening of protected doors and windows while the system is disarmed.

You must arm the burglary protection portion of your system before it will sense burglary alarms. Refer to the *Arming the System* section for detailed procedures and information.

### Security Codes

At the time of installation, you were asked to provide a personal 4-digit security or “Master User” code. You must enter the user code when arming and disarming the system, and when performing other system functions. As an additional security feature, other users who do not need to know your code can be assigned up to 32 different security codes. Refer to the *Security Codes* section for procedures on adding security codes to the system.

### Alarms

When an alarm occurs, the LYNX Touch internal sounder will sound for about 15-seconds, and the touch screen displays the zone(s) causing the alarm. After 15-seconds, the internal sounder stops temporarily and voice announcements of the zones in alarm begins. When these zones have been announced, the internal sounder sounds again and the cycle repeats itself, until the system is disarmed or until alarm bell timeout occurs. If your system is connected to a central monitoring station, an alarm message will be sent. To stop the alarm sounding, simply disarm the system. The zone(s) causing the alarm remain displayed indicating memory of alarm. Refer to the *Disarming the System* section for information about clearing the memory of alarm display

#### Important Note

If your system is equipped to report alarms over the internet via a WiFi Communications module, your router must remain powered-on at all times. Ask your Installer about this feature for additional information

### Two-Way Voice Feature

The control supports voice dialog between an operator at the central station and an individual at the premises. This feature allows the central station to listen, talk to or conduct a two-way conversation with an individual(s) at the premises and allows the operator to gather information about the nature and location of the alarm that may be helpful in responding to police or rescue departments.

















### LYNX Touch False Alarm Prevention Features

Many false alarms are caused by simple accidents, like forgetting to close a door when you leave. The LYNX Touch may include several features that help prevent false alarms and some of these are optional or programmable. Although turning off some of these features may provide additional security, it may also increase the chance of false alarms. Your installer can help you decide whether to use the features or not. The following provides a brief explanation of the features included with your security system that help prevent false alarms from occurring, and what you should do if such alarms occur.

- **Exit/Entry Delays:** Your security system has been programmed with delay times that allow you to exit the premises after arming, and to disarm the system upon entry, before an alarm occurs. If you leave the premises too late when exiting, or disarm too late when arriving home, it will cause a false alarm. If an alarm occurs, you should disarm the system immediately, and wait for your monitoring company to call you.
- **Exit Alarms:** Leaving the premises and forgetting to close the door is a common cause of false alarms. The security system will sound an alarm, and display “Exit Error”. The security system provides extra time for you to disarm the system before dialing your monitoring company. Disarming the system immediately may prevent a call to your monitoring company.
- **Exit Time Restart-Exit Delay Restart/Reset:** If you leave the premises and enter again before the exit delay has expired, the system will restart the exit time giving you more time to leave. If there are less than 10 seconds left to exit, the system will sound fast beeps, indicating an alarm will occur soon if you fail to exit or disarm immediately. If this occurs, disarm the system and arm it again when you are ready to leave. The Exit Delay can also be restarted by pressing the RESTART Icon.
- **Auto Stay Feature:** If you arm the system in the “AWAY” mode from the control’s keypad or an RF keypad but no one exits, the alarm system will automatically change to the “STAY” mode. This will prevent you from tripping alarms by remaining on premises. Disarm the system and arm away again when you are ready to leave.
- **Alarm Reporting Delay:** Your security system has a delay between the time a burglary alarm sounds, and the time the monitoring company is called. This delay gives you time to disarm the security system before the alarm is reported to the monitoring company. This delay is factory preset at 30 seconds, but may be increased or decreased by your installer.
- **False Alarms:** If a burglary or fire alarm condition occurs and the system has been disarmed, the keypad will display “Alarm Cancelled”. If this was a false alarm, wait for the monitoring company to call you. They will verify your security code or password and prevent them from calling emergency personnel to respond to a false alarm.

# SYSTEM OVERVIEW

















## Quick View of System Functions

Function	Press these Keys or Icons
<b>SECURITY FUNCTIONS</b>	
Check system status .....	 System
Arm in STAY mode.....	 Arm Stay + Code
Arm in Night STAY .....	 Arm Stay Select Arm Night + Code
Arm in AWAY mode .....	 Arm Away + Code
Arm in AWAY mode with Silent Exit .....	 Arm Away Select Silent Exit + Code
Restart exit delay.....	 Restart
Arm if Quick Arm is active* .....	 Arm Stay OR  Arm Away + Quick Arm button
* User code is not required if Quick Arm is active	
Disarm system and silence alarms.....	 Disarm + Code
<b>Note:</b> During Entry Delay or when an Alarm Condition exists, the LYNX Touch can be disarmed by entering the User Code. Entering the OFF key is not required	
Arm Instant.....	Set "Delay" tab to "Instant" then Arm STAY or AWAY
Bypass a zone(s).....	 Zones
<b>SYSTEM SETTINGS</b>	
Adjust Volume, Contrast or Brightness.....	 Settings
Restore/unmute user announcements .....	 Settings + Voice
Turn Chime mode On or Off.....	 Settings + Chime
Clean Touchscreen .....	 Settings +  Clean
<b>MESSAGE CENTER</b>	
Record a message .....	 Message
Play or Delete a message .....	 Message



# SYSTEM OVERVIEW

## Quick View of System Functions

Function	Press these Keys or Icons
<b>OTHER FUNCTIONS</b> (accessible from the Master User Screen)	
 + Master Code	
Set the time and date..... :	 Date Time
Add, delete or change a User Code* .....	 Users
* Only the Master Code can be used to add/delete a User	
Perform Tests .....	 Test + Applicable Test icon
View System Events .....	 Events
Program, edit or delete Reminders .....	 Reminders
<b>HOME AUTOMATION</b> (If equipped)	
Operate Garage Door .....	 + 
	 Switches
	OR
	 68° Thermostats
Manually operate Z-Wave Devices .....	 +  Locks
	OR
	 Water Valves
	OR
	 Scenes
	OR
Set Scenes, Schedules or Rules OR Run Scenes.. :	 +  Schedules
	OR
	 Rules

# SYSTEM OVERVIEW

## About the Touch Screen Control

### General

**\*\*IMPORTANT\*\***

If the LYNX Touch is beeping rapidly upon entering the premises, an alarm has occurred during your absence and an intruder may still be on the premises. LEAVE IMMEDIATELY and CONTACT THE POLICE from a nearby safe location.

The touch screen icons and keys allow you to control all system functions. Additionally, the touch screen display shows the zone and description of all system occurrences. When the speaker phone mode is active, a full-function telephone keypad is displayed on the touch screen.

The system also features a built-in sounder, which will sound during alarms and troubles and a built-in speaker announces system status. Additionally, the system "beeps" during certain system functions, such as during entry/exit delay times, in Chime mode, and when depressing any of the keys (to acknowledge the key press). The voice announcement volume is adjustable. The "beeps" that sound in response to alarms always sound at the maximum volume level however, the volume level for all other "beeps" (trouble, chime, exit/entry, etc) can be adjusted.

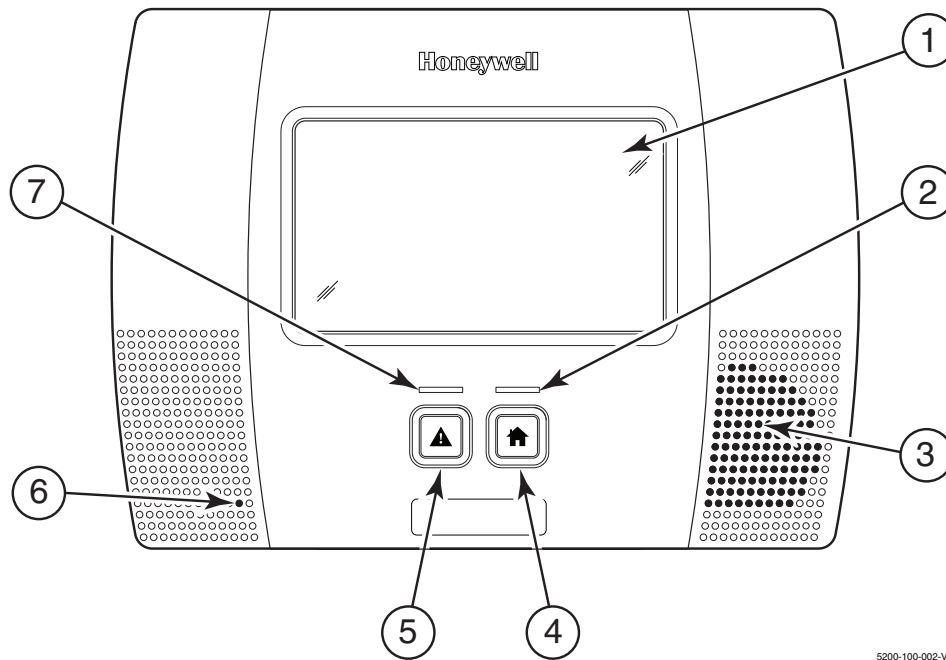













5200-100-002-V0

Index	Item	Description
1	Display Window	Color Liquid Crystal Display (LCD) Touch screen. Displays system status icons, time, system status information, user menus and the virtual keypad.
2	Ready LED Indicator (Green)	ON = System is ready to be armed OFF = System is armed Blinking = System is disarmed, and not ready to be armed (a fault exists) Blinking alternately with Ready LED = Speaker phone mode is active
3	Speaker	Source of audible internal warning and confirmation sounds, status announcements, as well as alarms (see "Summary of Audible Notifications").
4	Home key	Used to exit from a screen or return to the Home Screen.
5	Panic key	When depressed for 4 seconds, the virtual panic icons are displayed on the touch screen.
6	Microphone	Used to record personal messages via the Message Center, and for Two-way Voice and Speaker Phone operation.
7	Armed LED Indicator (Red)	ON = System is armed (STAY or AWAY) OFF = System is disarmed Blinking = System armed, and an Alarm or Fault has occurred. Blinking alternately with Ready LED = Speaker phone mode is active









**About the Display and Indicators**

**Display Definitions**

ICON	TEXT	DEFINITION
	Ready to Arm	Displayed along with the the text “Ready To Arm” when system is Disarmed and ready to arm.
	Armed Away	“Armed Away” is displayed along the top of the screen. An armed away icon along with “Armed Away” is displayed after the exit delay expires.
	Armed Stay	“Armed Stay” is displayed along the top of the screen. An armed stay icon along with “Armed Stay” is displayed after the exit delay expires.
	Exit Now 28 Seconds	“Armed Stay – Exit Now” or “Armed Away – Exit Now” is displayed in a red status bar along the top of the screen. An exit icon along with “Exit Now” and the time remaining (i.e.; “28 Seconds”) is displayed during the exit delay.
	Alarm	“Alarm” is displayed in a red status bar along the top of the screen. An alarm (bell) icon along with “Alarm” is displayed alternately with the Zone that has caused the alarm.
 OR 	Fault (Zone No.& Description)	“Not Ready To Arm – Fault” is displayed in a yellow status bar along the top of the screen. An open window or door icon along with the zone descriptor and “Window” or “Door” is displayed when a window or entry/exit fault has been detected. OR Displayed alternately with the alarm (bell) icon and “Alarm”. “Alarm” is also displayed in a red status bar along the top of the screen.
	Fire OR Fire Alarm 95 Fire	The fire icon is displayed with alternating text “Fire” and “Fire Alarm 95 Fire”. “Fire Alarm” is also displayed in a red status bar along the top of the screen.
	Alarm 96 Medical	The Medical icon displayed when a medical alarm is activated. “Alarm” is also displayed in a red status bar along the top of the screen. (If programmed for display by your installer)
	Alarm 99 Police	The alarm (bell) icon when a burglary alarm is activated. “Alarm” is also displayed in a red status bar along the top of the screen. (If programmed for display by your installer) No display if 24 Hour Silent Response Type has been programmed.
	CO Alarm	Displayed alternately with Carbon Monoxide when a CO alarm is activated. “CO Alarm” is also displayed in a red status bar along the top of the screen.
	Cover Tamper	A check system icon along with “Cover Tamper” is displayed when a cover tamper has been detected. “Ready To Arm – System Trouble” is displayed in a yellow status bar along the top of the screen.
	Reporter Failure	The system has identified a problem with the telephone dialer.

## **SYSTEM OVERVIEW**

### **About the Display and Indicators**

<b>ICON</b>	<b>TEXT</b>	<b>DEFINITION</b>
	Low Battery	“Not Ready To Arm – System Trouble” is displayed in a yellow status bar along the top of the screen. A low battery icon along with “Low Battery” is displayed when the system’s backup battery power is low.
	90 RF Jam	Appears when the system has detected an RF jamming condition or excessive interference.
	94 Phone Line Cut	Appears when the system has detected a loss of telephone service.
	AC Loss	Displayed when the system has lost AC power. “Ready To Arm – System Trouble” is displayed in a yellow status bar along the top of the screen.
	Automation	Displayed when the system has detected a Z-Wave Device Failure
	Fault * Main Garage Door	Displayed when the Garage Door has been opened. Ready To Arm – Fault” is displayed in a yellow status bar along the top of the screen. (* Applicable Zone Number)
	(Not applicable)	Displayed in the upper left corner of the status bar. Indicates that the system is connected to a WiFi source and the signal strength.
	Not applicable)	Displayed in the upper left corner of the status bar. Indicates that the system is NOT connected to a WiFi source.

### LCD Display

LYNX Touch's Liquid Crystal Display (LCD) touch screen displays variable icons and text on "screens". The screen displays status icons and associated text, the current time, system status information and menu choices. The system status is displayed in a colored status bar along the top of the screen. The status bar color is variable and will change between Red, Yellow and Green as the system status changes.

The Menu area includes a list of commands, or choices that apply to the current selection. The status area provides information about various system events. A Home Screen is displayed whenever power is applied to the system. In addition the Green (Ready) LED will be lit.

**Note:** The displayed screens may vary slightly depending upon the devices and services that are installed in or connected to your system.

### Navigation Keys

Navigating through the screens is accomplished by lightly touching the menu item on the touch screen. Once activated, the control will take you to the next screen. Selecting the "Home" (cancel) key will return you to the Home Screen at any time unless System Programming mode is active. Pressing the "↶" Key or "Back" tab will return you to the previous screen.

**Note:** You may find it convenient to adjust the volume setting before entering the Program (Tools) Mode. This will allow you to clearly hear the feedback announcements or system beeps in the Programming Mode, of the system's built-in speaker. To adjust the volume, select "More" on the "home Screen" and then select "Settings". Adjust the volume using the slide shown on the Settings screen and then select "Save" to accept.

### Home Screen

System Status is displayed at the top of the Home Screen. The time and date is displayed on the left third of the screen and the Security, Automation, Video and Notices icons or "buttons" are displayed on the right side of the screen. If your system is connected to Total Connect Services the Home Screen will display the time, date and weather (as applicable) on the left third of the screen. Additionally News, Traffic and Notices selection icons or "buttons" are displayed.

**Note:** Access to Text Messages, Weather, News and Traffic and other web content requires Total Connect Services. Ask your Installer, which of these features have been programmed in your system.

- **Security** – Provides access to Security Screen.
- **Automation** – Provides access to the Device and Z-Wave Home Automation Management screen.
- **Video** – Provides Access to the Video Control Screen
- **Notices** – Provides access to the Dealer Notification Message Center (TotalConnect Services required)
- **News** – Provides access to News Updates (TotalConnect Services required)
- **Traffic** – Provides access to Traffic Updates (TotalConnect Services required)
- **5-Day Forecast** – Provides access to Local 5-Day Weather forecast (TotalConnect Services required)
- **Weather** – Provides local forecast and severe weather alerts (TotalConnect Services required)
- **Location** – Provides access to program location information (City, State, Country, Zip Code) and enable single day weather display and Sunrise/Sunset scheduling. (Requires GSM/Cellular or WiFi communication module). Check with your installer to see if your system is equipped with a Communications Module.

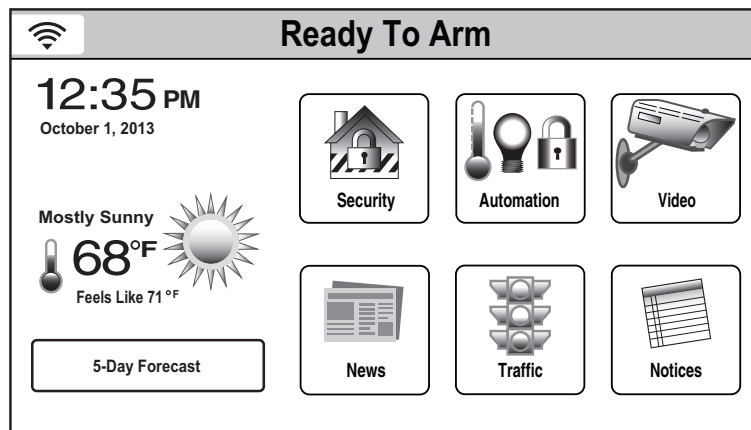

LYNX Touch Home Screen (Typical)

5200-100-001-V0

# SYSTEM OVERVIEW

## Navigating Menus

### Function Keys

Two Function Keys allow you to quickly access Panic functions OR return to the Home Screen.

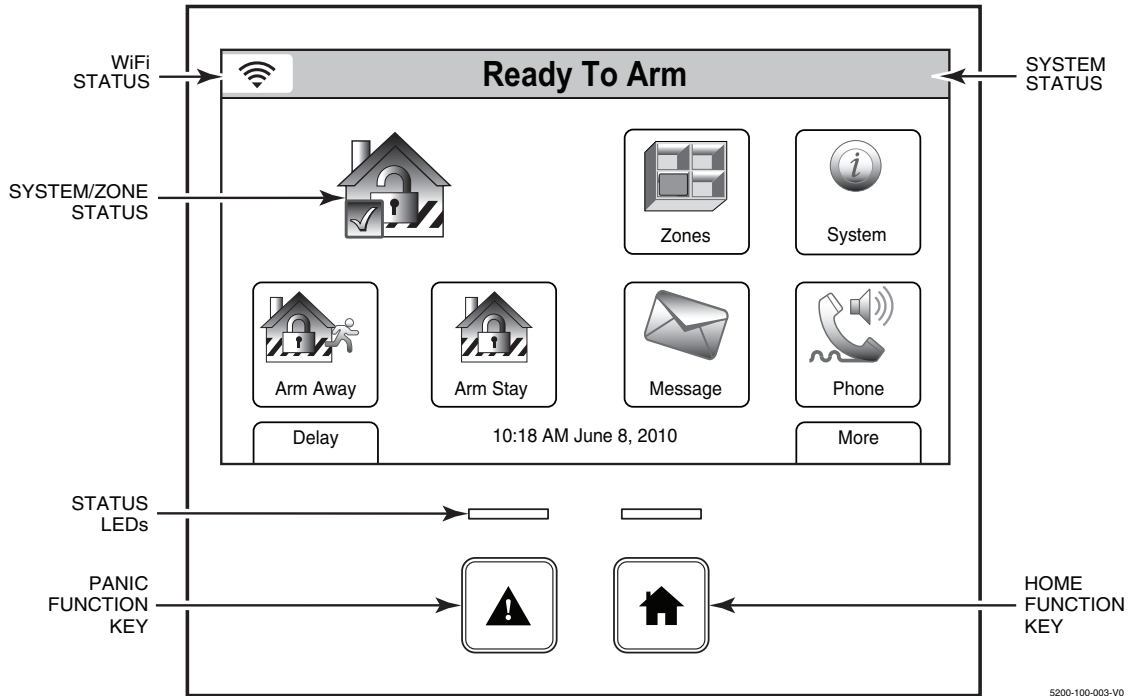

LYNX Touch Security Screen (Page 1)

### Menu Screens

System Status is displayed at the top of each screen. The time and date are displayed at the bottom of the Security Screen.

### Menus

#### Security Screen Menu

The two-page Security Screen provides access to an Unrestricted Menu that displays the system status and selection icons or “buttons”. The appearance of the display and the location of the icons varies dependent upon the options that have been programmed. Check with your Installer. The “More/Back” button is used to toggle between the Security Screen pages.

Icon or Button	Function
	Used to Arm the system in Away mode. (Displayed on both pages of the Security screen)
	Used to Arm the system in Stay mode. (Displayed on both pages of the Security screen)
	Provides access to Zone information and options.
	Provides information about system status.
	Provides access to Message Center.
	Provides access to Speaker Phone mode (if programmed)







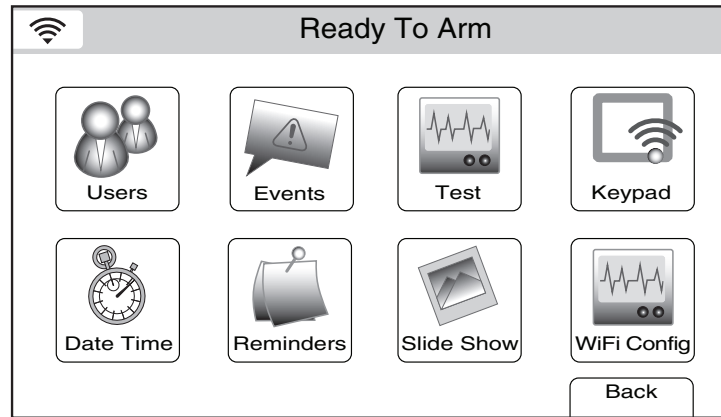

Icon or Button	Function
	Provides access to Master User Programming Menu (Master User Code required for access).
	Provides access to Touch Screen functions including Brightness, Contrast, Volume, Voice, Chime and Ringer.
<b>Delay/Instant</b>	Toggles between Delay and Instant to enable the exit delay or instant arming options.
<b>More/Back</b>	Advances system to second page of the Security Screen/Returns system to first page of the Security Screen.

**Master Menu**

The User Menu provides access to User configurable features. The appearance of the icons varies dependent upon the options that have been programmed. Entering the Master User Code is required to access the Master menu.



5200-100-036-V0

Icon or Button	Function
 <p>Users</p>	Allows Master User to add or remove User Codes
 <p>Events</p>	Allows Master User to view system events.
 <p>Test</p>	Allows Master User to Test the system.
 <p>Keypad</p>	Allows Master user to enroll and view information associated with Mobile Device(s).
 <p>Date Time</p>	Used to program Date and Time.
 <p>Reminders</p>	Allows Master User to add or remove local and "Follow Me" reminders.
 <p>Slide Show</p>	Allows Master User to program screensaver options.
 <p>WiFi Config</p>	Provides access to WiFi configuration screen (Requires the installation of WiFi Communications Module).
 <p>Back</p>	Returns system to the First Page of the Security Screen.

# **SECURING THE PREMISES**

---

## **System Status**

### **General Information**

Before arming your system, all protected doors, windows, and other protection zones must be closed or bypassed (refer to the *Bypassing Zones* section).

**Ready LED:** The Green (Ready) indicator on the control will be lit if the system is ready to be armed. If the LED is blinking, the system is not ready to arm.

**VOLUME LEVEL:** The volume level of system announcements can be increased or decreased. Refer to the *System Adjustment* section for the procedure.

### **System Can Be Armed**

The Green Ready LED will be lit steadily once all protection zones have been closed or bypassed. Additionally, “Ready to Arm” is displayed in a green band at the top of the touch screen. You may now arm the system.



### Arming in Stay Mode

Use this mode when you are staying home, but expect someone to use the entrance door later. Close all protected perimeter windows and doors before arming. The green Ready indicator on the control should be lit if the system is ready to be armed. When armed in STAY mode, the system will sound an alarm if a protected door or window is opened, but you may otherwise move freely throughout the premises. Late arrivals can enter through the designated entrance door without causing an alarm, but they must disarm the system within the entry delay period or an alarm will occur. If Quick Arm was programmed by the installer, you do not need to enter the security code to arm the system. The security code must always be used to disarm the system, however.

If your system's Garage Door Zone has been programmed for burglary protection, the system can be armed while the Garage Door is opened. A "Fault" will be displayed by the control but will clear once the door has been closed. The Garage Door zone will be subsequently be monitored by the system.



**The Guest Code and Installer Code cannot disarm the system unless it was used to arm the system. In addition, if the system is armed by pressing via Quick-Arming, neither the Guest Code nor Installer Code can disarm the system.**

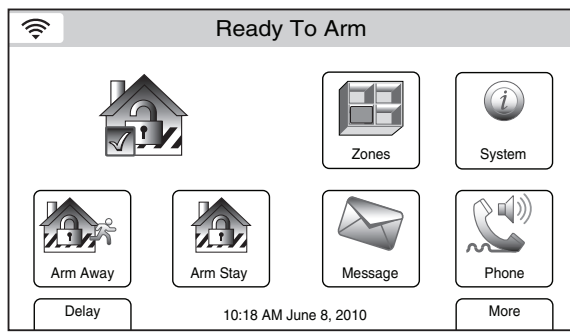

1. Select the Arm Stay icon, the system beeps once and displays a keypad.

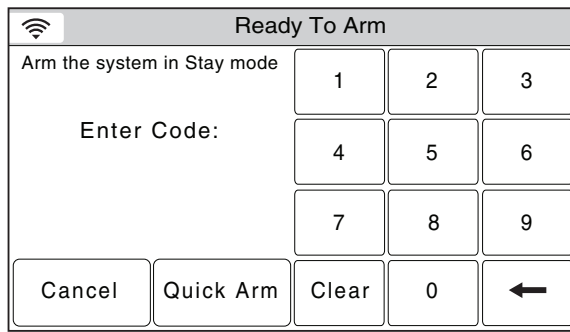

2. Enter a valid User Code.

OR

If Quick Arm has been enabled, select the "Quick Arm" icon.

**Note:** If a valid user code is not entered or the Confirm icon has not been selected within 10 seconds, the system returns to the "security" screen and it will not be armed.

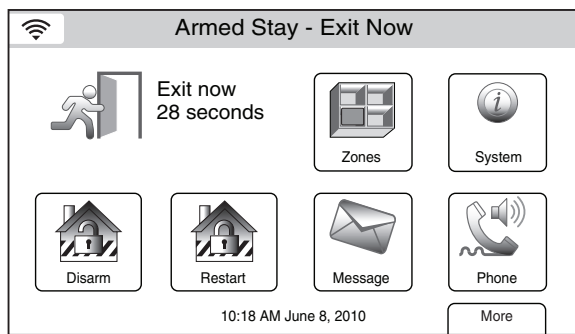

3. The system beeps three times and announces "Armed Stay Exit Now". The exit delay screen is displayed. If programmed the display counts down the time remaining in the exit delay.

# SECURING THE PREMISES

## Arming the System

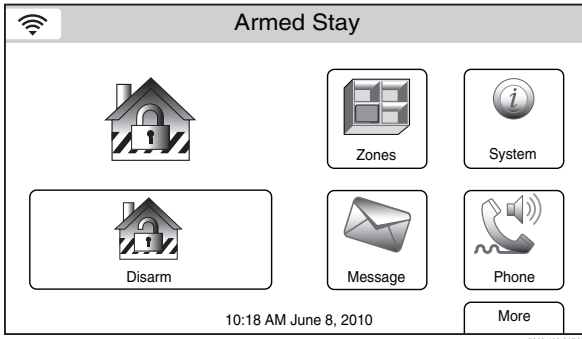

4. At the end of the exit delay the system announces "Armed Stay" and displays the "Armed Stay" screen.



If an invalid User Code is entered or if a valid user code has not been entered within 10 seconds, the system will return to the "security" screen and it will not be armed.

### Auto Stay Arming Feature

If this feature is enabled by installer, the LYNX Touch, when armed AWAY from the control's keypad or a Wireless Keypad, automatically switches to the STAY mode if the Exit Time expires and no exit has been made. Exit must be made through an Entry/Exit Zone (door). If exit is made through a Garage Door, the system will automatically switch to the STAY mode when the Exit Time expires.

**NOTE:** If the exit route entry/exit sensor is in a check condition or has been bypassed it will result in a loss of interior protection because the alarm system will arm STAY in this case. Consult with your installer for servicing of the entry exit zones or to turn off this feature if a check condition on entry exit zones occurs.

### Arming in Night Stay Mode

Use this mode when you are staying home, but require increased security. The mode Arms same as STAY mode, but also arms preselected interior sensors (programmed by your installer), while other interior sensors are left disarmed. This mode can be armed when you are staying home but expect someone to use the entrance door later. However, persons entering later can enter through an entry/exit door but they must disarm the system **and** must not violate any of the programmed interior zones to avoid sounding an alarm. Close all protected perimeter windows and doors before arming. The green Ready indicator on the control should be lit if the system is ready to be armed. When armed in Night STAY mode, the system will sound an alarm if a protected zone is faulted, but you may otherwise move freely throughout the premises. Late arrivals can enter through the designated entrance door without causing an alarm, but they must disarm the system within the entry delay period or an alarm will occur. If Quick Arm was programmed by the installer, you do not need to enter the security code to arm the system. The security code must always be used to disarm the system, however.



When NIGHT-STAY mode is on, the selected interior zones are armed and cause an alarm if anyone enters those areas (e.g., waking in the middle of the night). To avoid sounding an alarm, you must disarm the system before any activity takes place in those interior zones.

The Guest Code and Installer Code cannot disarm the system unless it was used to arm the system. In addition, if the system is armed by pressing via Quick-Arming, neither the Guest Code nor Installer Code can disarm the system.

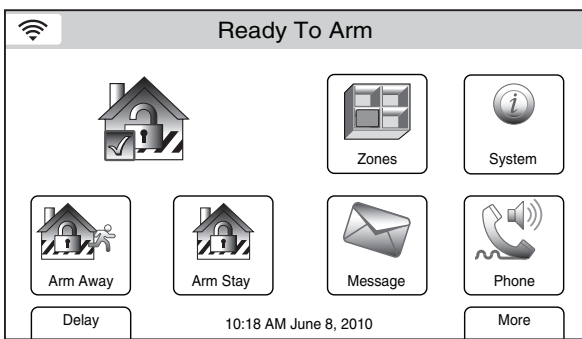

1. Select the Arm Stay icon, the system beeps once and displays a keypad.

# SECURING THE PREMISES

## Arming the System

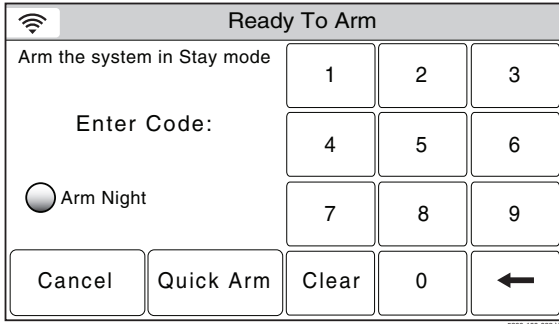

2. Select the "Arm Night", then enter a valid User Code.

OR

If Quick Arm has been enabled, select the "Quick Arm" icon.

**Note:** If a valid user code is not entered or the Confirm icon has not been selected within 10 seconds, the system returns to the "security" screen and it will not be armed.

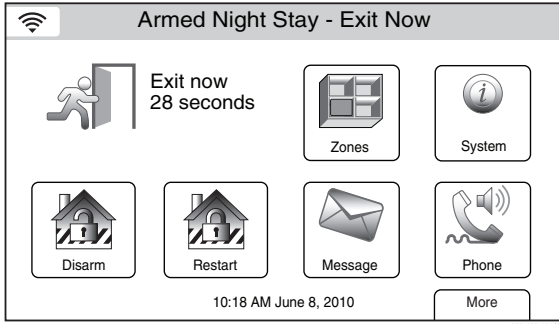

3. The system beeps three times and announces "Armed Night Stay Exit Now". The exit delay screen is displayed. If programmed the display counts down the time remaining in the exit delay.

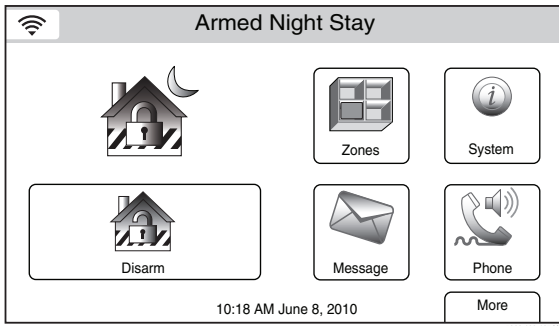

4. At the end of the exit delay the system announces "Armed Night Stay" and displays the "Armed Night Stay" screen.



If an invalid User Code is entered or if a valid user code has not been entered within 10 seconds, the system will return to the "home" screen and it will not be armed.

# SECURING THE PREMISES

## Arming the System

### Arming In Away Mode

Use this mode when no one will be staying on the premises. Close all protected perimeter windows and doors before arming. The green Ready indicator on the control should be lit if the system is ready to be armed. When armed in AWAY mode, the system will sound an alarm if a protected door or window is opened, or if any movement is detected inside the premises, when infrared detection devices are used. You may leave through a designated entrance door during the exit delay period without causing an alarm. You may also re-enter through the entrance door, but you must disarm the system within the entry delay period or an alarm will occur. If Quick Arm was programmed by the installer, you do not need to enter the security code to arm the system. The security code must always be used to disarm the system, however. If your system's Garage Door Zone has been programmed for burglary protection, the system can be armed while the Garage Door is opened. A "Fault" will be displayed by the control but will clear once the door has been closed. The Garage Door zone will subsequently be monitored by the system. If Auto Stay Arming is enabled, the system will Arm in STAY mode if the Exit Time expires and no exit has been made. Refer to *Auto Stay Arming Feature* for additional information.



**The Guest Code and Installer Code cannot disarm the system unless it was used to arm the system. In addition, if the system is armed by pressing via Quick-Arming, neither the Guest Code nor Installer Code can disarm the system.**

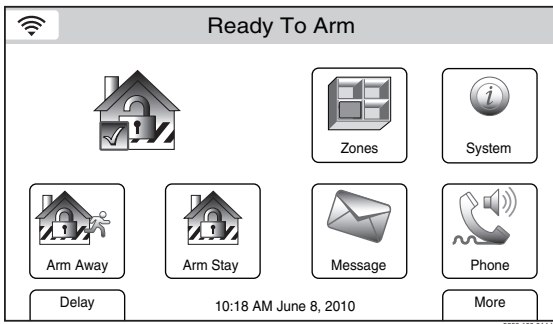

1. Select the Arm Away icon, the system beeps once and displays a keypad.

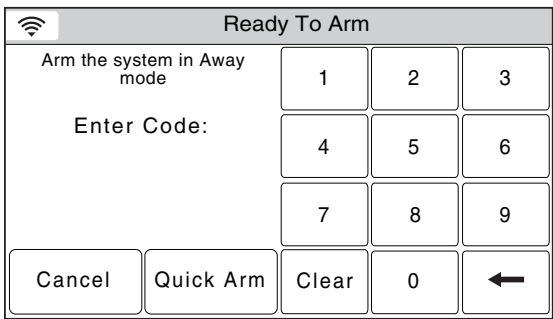

2. Enter a valid User Code.  
OR  
If Quick Arm has been enabled, select the "Quick Arm" icon. The system beeps two times and announces "Armed Away Exit Now". The exit delay screen is displayed. If programmed the display counts down the time remaining in the exit delay in seconds.

**Note:** If a valid user code is not entered or the Confirm icon has not been selected within 10 seconds, the system will return to the "security" screen and it will not be armed.

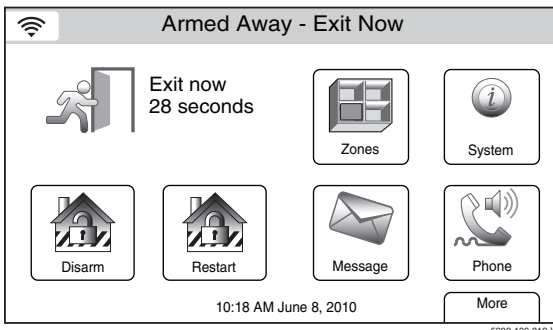

3. If "Exit Warning" has been enabled, the system will continue to beep throughout the exit delay. Rapid beeps will sound for the final 10 seconds of the delay period.

# SECURING THE PREMISES

## Arming the System

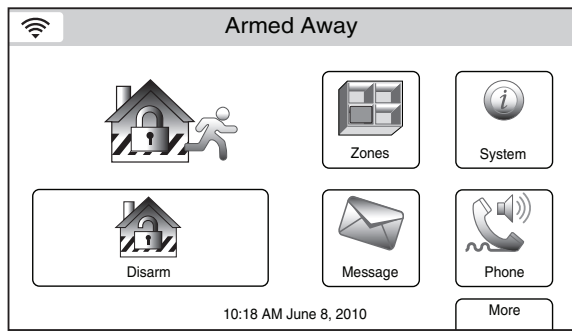

4. At the end of the exit delay the system will announce "Armed Away" and displays the "Armed Away" screen.



If an invalid User Code is entered or if a valid user code has not been entered within 10 seconds, the system will return to the "security" screen and it will not be armed.

### Silent Exit Feature

If Silent Exit feature is enabled when the LYNX Touch is armed AWAY, the Exit beeps will be silenced. In addition, the panel will double the exit delay time before arming AWAY.

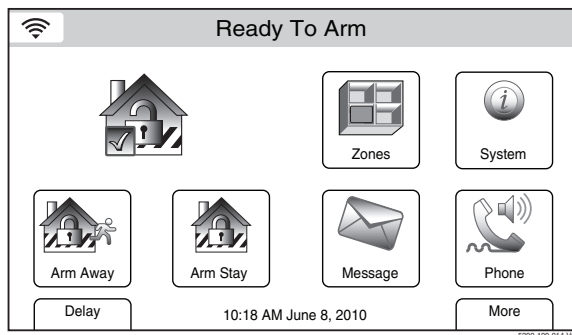

1. Select the Arm Away icon, the system displays a keypad.

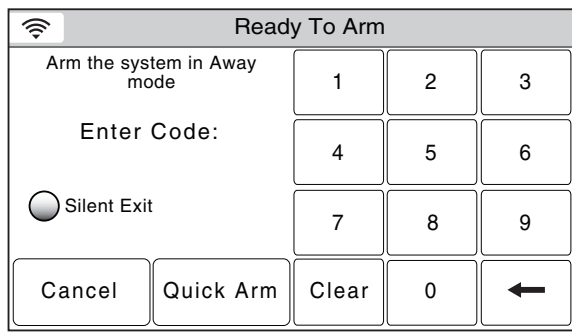

2. Select the Silent Exit button. If enabled, the Silent Exit button turns green. Enter a valid User Code.  
OR  
If Quick Arm has been enabled, select the "Quick Arm" icon.

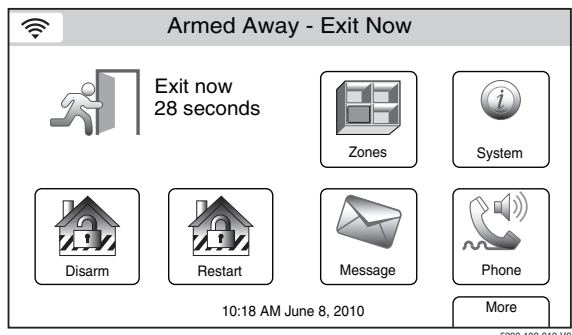

3. The system beeps two times and announces "Armed Away Exit Now". The exit delay screen is displayed. If programmed the display counts down the time remaining in the exit delay in seconds.

# SECURING THE PREMISES

## Arming the System

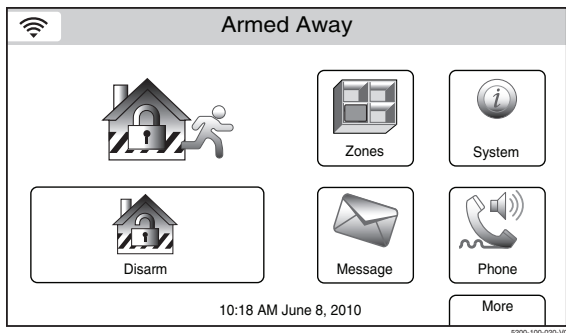

4. At the end of the exit delay the system will announce "Armed Away" and displays the "Armed Away" screen.



If an invalid User Code is entered or if a valid user code has not been entered within 10 seconds, the system will return to the "security" screen and it will not be armed.

### Arming the System with no delay (Instant)

Use “Instant” with Stay mode when you are staying home and do not expect anyone to use the entrance door. Use “Instant” with Away mode when the premises will be vacant for extended periods of time such as vacations, etc. When armed with “Instant”, the system will sound an alarm if a protected door or window is opened, including the entrance door. You may leave through the entrance door during the exit delay period without causing an alarm, but an alarm will sound as soon as someone reenters.

When armed “Instant” with Stay mode, the control beeps three times and displays the “Armed Stay Instant” message. In addition, the red Armed indicator lights and the system announces “*Armed Stay Instant –exit now*”. When armed “Instant” with Away mode, the control beeps two times and displays the “Armed Away Instant” message. If Exit Warning is enabled the system beeps continuously for the duration of the exit delay. In addition, the red Armed indicator lights and the system announces “*Armed Away Instant –exit now*”.

### To Arm the System with No Delay (Instant)

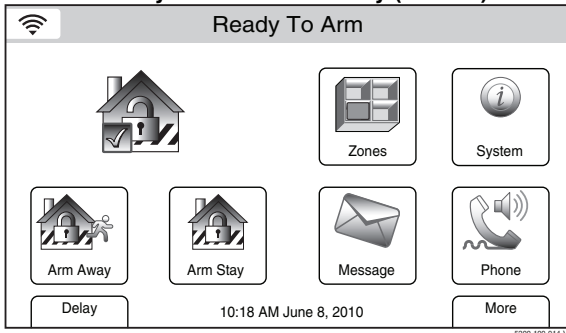

1. Select the “Delay” tab on the Security Screen. The icon “toggles” and “Instant” is displayed.
2. Arm the system in the “Stay” or Away” mode normally.

**Note:** The entry delay time is eliminated when “Instant” is selected.

### Quick Exit

If active, you can restart the exit delay at any time after the system has been armed in Stay or Away mode by selecting the “Quick Exit” icon. This avoids having the user disarm then re-arm the system after allowing someone to enter or exit. The system will re-arm once the exit delay expires.

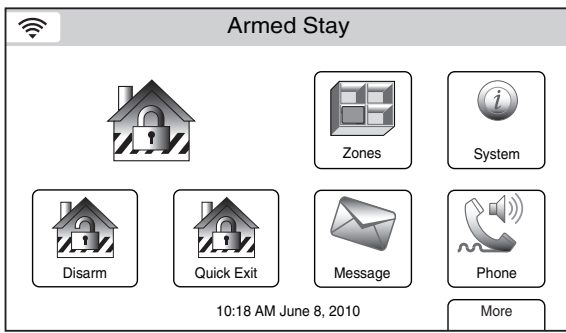

1. Select the “Quick Exit” icon to restart the exit delay.

**Note:** Quick Exit is active in Away mode when: Auto Stay mode is enabled and no entry/exit zone has been faulted during the exit delay period.

# SECURING THE PREMISES

## Entry/Exit Delays

### Exit Delay

Exit delay begins immediately after arming the system, and gives you time to leave through the designated exit door without setting off an alarm. The system display will count down the time remaining in the exit delay, if programmed by your installer. If the system has been Armed Away, a slow beeping will sound throughout the exit delay period, if programmed by your installer. The exit door must be closed before the end of the exit delay. During the last 10 seconds of the exit delay fast beeps will sound as a warning that the delay time is nearing its end. The exit beeps cannot be silenced.

### Restarting Exit Delay While System Armed

Ask your installer if this feature is active for your system. If active, you can restart the exit delay one time after arming in Stay or Away mode during the exit delay by selecting the “Restart” key. This will allow extra time for someone to enter or exit or re-enter the property before the system is armed.

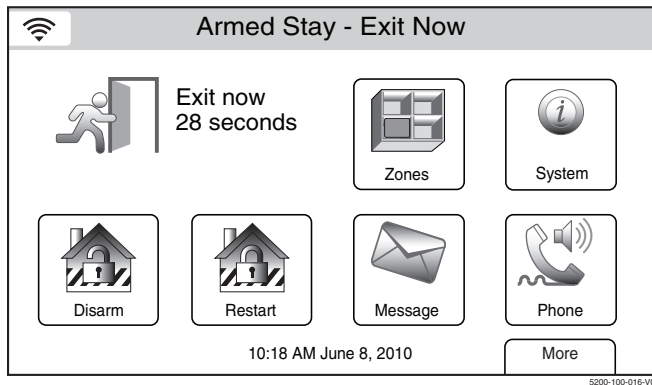

### Exit Alarms

To minimize false alarms sent to the alarm monitoring company, your system may have been programmed for this feature. Ask your installer if Exit Alarm is active for your system.

Whenever you arm the system, the exit delay begins. If an entry/exit door or interior zone is faulted when the exit delay ends (e.g., exit door left open), the system sounds an alarm and starts the entry delay timer. If you disarm the system before the entry delay ends, the alarm sound stops and the message “Alarm Cancelled” is displayed, in the system bar. Additionally, Alarm and the faulted zone are displayed with their associated icons in the system/zone status area. No message is sent to the alarm monitoring company. To clear the exit alarm condition, the open zone must be secured. To clear the display, select the “Disarm” icon OR depress the “Off” key and then enter your security code.

If you do not disarm the system before the entry delay ends, and an entry/exit door or interior zone is still open, the alarm sound continues and an "exit alarm" message is sent to the alarm monitoring company. The message “Alarm Exit Error” is displayed, in the system bar. Additionally, Alarm and the faulted zone are displayed with their associated icons in the system/zone status area. The alarm will continue to sound until the system is disarmed or timeout occurs. To stop the alarm, the system must be disarmed by selecting the “Disarm” icon OR depressing the “Off” key and then entering your security code. The message “Alarm Cancelled” is displayed, in the system bar, indicating that the alarm has been cancelled (if this feature is enabled by the installer). “Alarm” and the faulted zone continue to be displayed with their associated icons in the system/zone status area. To clear the display, select the “Disarm” icon OR depress the “Off” key and then enter your security code a second time. An exit alarm also results if an entry/exit door or interior zone is faulted within two minutes after the end of the exit delay.

### Auto Exit Delay Reset

Ask your installer if this feature is active for your system. If active, your exit delay will restart if an Entry/Exit door is reopened (during exit delay) after you have re-entered the premises.



**Entry Delay**

Entry Delays give you time to disarm the system when you re-enter through the designated entrance door. You must disarm the system before the entry delay period ends, or an alarm will occur. The control beeps during the entry delay period, reminding you to disarm the system. There are two entry delays (if programmed). The first is for your primary entrance and the second can be used for a secondary entrance, where a longer delay is required to walk to the control to disarm the system. You can also arm the system with no entry delay at all by selecting the “Delay” icon prior to arming the system. This will toggle the system to “Instant”, which can provide greater security while on the premises or while away for extended periods of time. See *Arming the System* section for procedure. See your installer for delay times programmed for your system.

Exit Delay:  45, 60, 90 seconds, 2 minutes

Entry Delay 1:  None, 15, 30, 45, 60, 90 seconds, 2, 3, 4 minutes

Entry Delay 2:  None, 15, 30, 45, 60, 90 seconds, 2, 3, 4 minutes

<b>LYNX Touch (L5200CN) Canada Exit/Entry Delay Times</b>	
Exit Delay:	<input type="checkbox"/> None, 15, 30, 45, 60, 90 seconds, 2 minutes
Entry Delay 1:	<input type="checkbox"/> None, 15, 30, 45, 60, 90 seconds, 2 minutes
Entry Delay 2:	<input type="checkbox"/> None, 15, 30, 45, 60, 90 seconds, 2 minutes

# SECURING THE PREMISES

## Disarming the System

Select the “Disarm” icon or the “Off” key to disarm the system and to silence alarm and trouble sounds. See the *Summary of Audible & Visual Notifications* section for information, which will help you to distinguish between fire and burglary alarm sounds. During Entry Delay or when an Alarm Condition exists, the system will be disarmed as soon as the correct user code is entered on the touch screen. Selecting the Off key is not required. The entry beeps or alarm sound can be silenced by pressing any key however, it will restart in 10 seconds if the correct User Code is not entered. The Ready indicator will light (if no alarms have occurred while armed) and the control will beep once to confirm that the system is disarmed.

### \*\*IMPORTANT\*\*

If the LYNX Touch is beeping rapidly upon entering the premises, an alarm has occurred during your absence and an intruder may still be on the premises. LEAVE IMMEDIATELY and CONTACT THE POLICE from a nearby safe location.

### Disarming the System

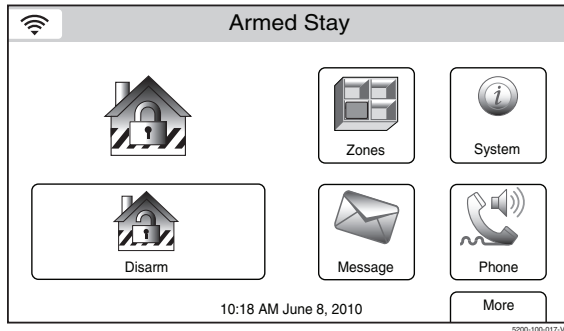

1. Select the “Disarm” icon. The system beeps once and displays a keypad.

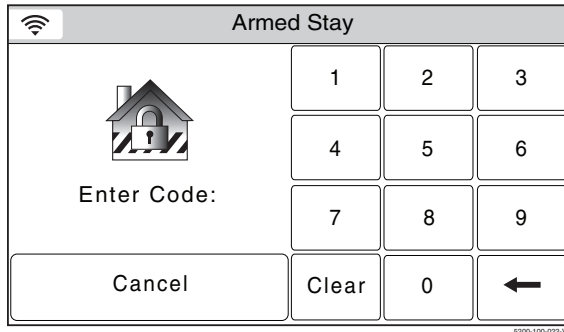

2. Enter a valid Code. The system beeps once and announces “Disarmed Ready to Arm”.

**Note:** If a valid user code is not entered or the Confirm icon has not been selected within 30 seconds, the system returns to the “security” screen and it will not be disarmed.



If an invalid User Code is entered, system will return to the Security Screen.

### Disarming the System During Entry Delay

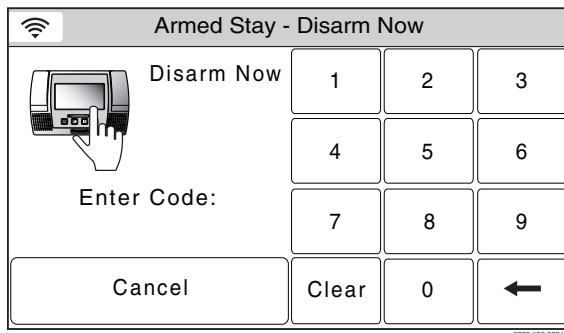

Upon entering the premise when the system is armed, the control announces “disarm system now”.

1. Enter a valid Code. The system beeps once and announces “Disarmed Ready to Arm”.

**Note:** If a valid user code is not entered before the programmed entry delay occurs, the system enters alarm mode.

### When an Alarm Occurs

When an alarm has occurred, the touch screen displays the zone number(s) that caused the alarm and the type of alarm (e.g., “Fire Alarm”). These messages remain displayed until cleared by a user. To clear the display, note the zone number that is displayed and enter a valid code. If the fault cannot be corrected, notify your alarm company.

### Disarming the System and Silencing Alarms

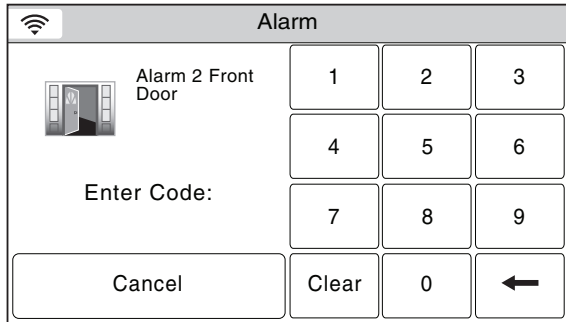

1. Enter a valid Code. The system beeps once and announces “Disarmed Ready to Arm”.

**Note:** If a valid user code is not entered before the programmed entry delay occurs, the system remains in alarm mode.

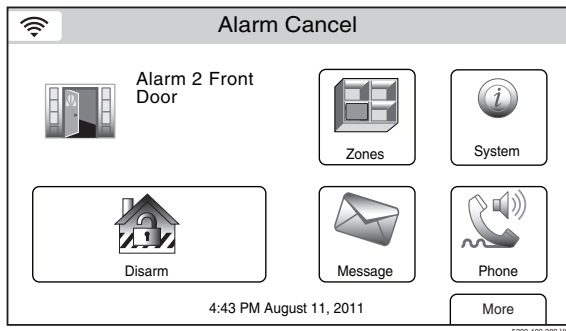

2. “Alarm Cancel” is displayed in a red band along with the zone that caused the alarm. Select the “Disarm” icon and enter a valid code again to clear the alarm. The system beeps once, returns to the Security Screen and announces “Disarmed Ready to Arm”.

# SECURING THE PREMISES

## Bypassing Protection Zones

### Bypassing Individual Zones

The Bypass feature can be used when you want to intentionally arm your system with one or more zones unprotected. Bypassed zones are unprotected and will not cause an alarm when violated while your system is armed. **All bypasses are removed when the system is disarmed. The system will not allow Panic, Fire or CO zones to be bypassed.**

### Bypassing Zones

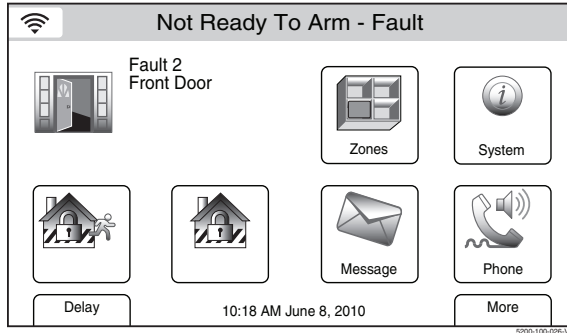

1. With the system in the disarmed state, select the “Zones” icon. The system displays the Zones/Bypass screen.

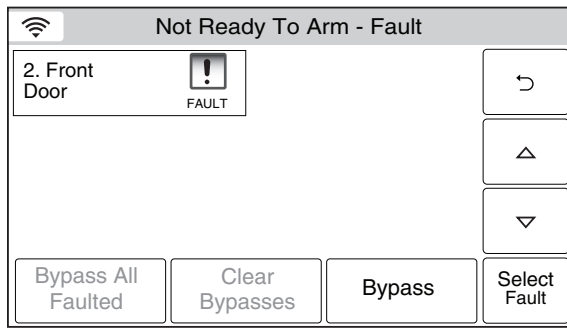

2. Select the zone(s) that you wish to bypass and then select “Bypass” OR if the “Force Bypass” feature has been programmed by your Installer, selecting the “Bypass All Faulted” button allows you to bypass all faulted zones (excluding Panic, Fire or CO zones). The system displays a keypad.

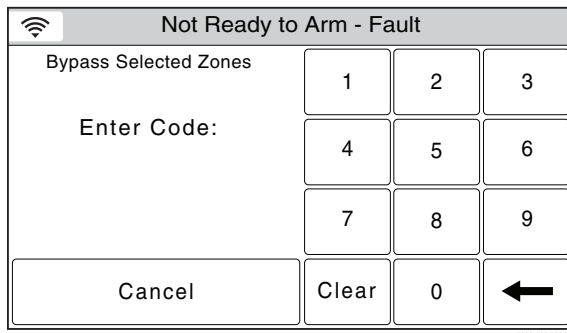

3. Enter a valid Code. The system returns to the Bypass screen and the zone(s) that are bypassed will be displayed.
4. Select the ↶ icon to return to the Security Screen.
5. Arm the system normally. See *Arming the System* section for the procedure.

# SECURING THE PREMISES

## Bypassing Protection Zones

### Displaying/Clearing Bypassed Zones

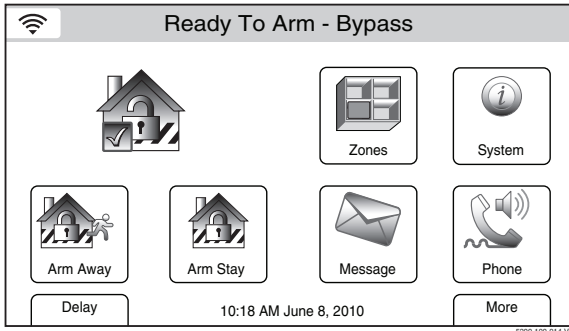

1. With the system in the disarmed state, select the “Zones” icon. The system displays the Zone screen and the status for each zone will be indicated.
2. Use the “▲” “▼” buttons to scroll to additional pages and view the zone status.
3. If you select the “Select All” button it scrolls through the following: “Select All”, “Select Alarm”, “Select Trouble”, “Select Fault” and “Select Bypassed”. The system displays the associated zones.

**Note:** If one or more zones has been bypassed the “Clear Bypasses” button will be highlighted.

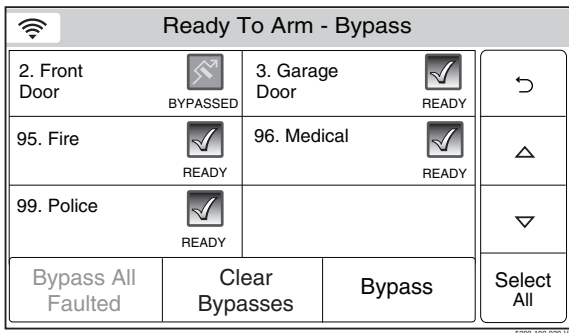

4. To clear the bypass, select the “Clear Bypasses” button.
5. Enter a valid code on the displayed keypad. The system returns to the Zones screen.
6. Select the ↻ icon to return to the Security Screen.

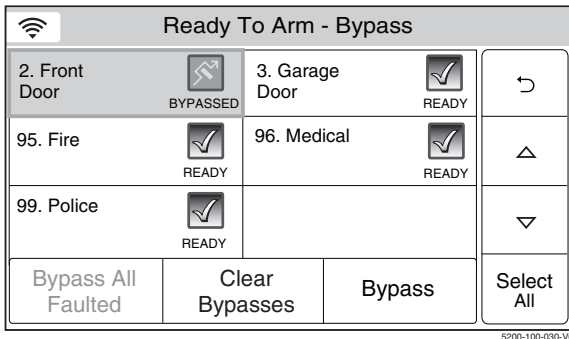

# SECURING THE PREMISES



## Panic Keys

### Panic Keys

Your system may have been programmed to use special icons to manually activate panic functions. The functions that might be programmed are listed below. See your installer for the function(s) that may have been programmed for your system.

**Note:** Your installer should advise which functions are active in your system.

### Panic Icons

Icon	Function
 Fire	When activated, alerts the alarm monitoring company that a fire condition exists.
 Police	When activated, alerts the alarm monitoring company that a police emergency exists.
 Medical	When activated, alerts the alarm monitoring company that a health emergency exists.

### Types of Panic Alarms

- A **silent emergency/silent alarm** sends an alarm signal to the alarm monitoring company, if your system is connected to an alarm monitoring company, but there will be no audible alarms or visual displays.
- An **audible emergency/audible alarm** sends an emergency message to the alarm monitoring company, if your system is connected to an alarm monitoring company, and sounds a loud, steady alarm at your control. (“ALARM” will be announced and the Alarm icon is displayed along with “Alarm” and “Alarm 99 Police” alternately.
- A **personal emergency/aux alarm** sends an emergency message to the alarm monitoring company, if your system is connected to an alarm monitoring company, and sounds at controls, but not at external sounders. (“ALARM” will be announced and the Alarm icon is displayed along with “Alarm” and with “Alarm 96 Medical”.
- A **fire alarm** sends a fire alarm message to the alarm monitoring company, if your system is connected to an alarm monitoring company, and uniquely activates the sounder. The Fire Alarm icon is displayed along with “Fire Alarm 95 Fire”.

### Activating a Panic Alarm

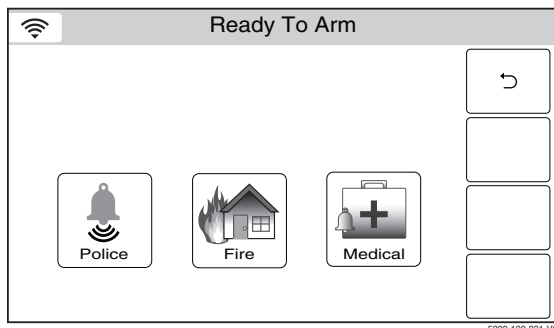

1. With the system in the disarmed or armed state, depress and hold the “Panic” key until the system displays the Panic screen (approximately 3-4 seconds).
2. Touch the desired panic icon on the screen.
3. If applicable, the alarm sounds and the associated icon is displayed.

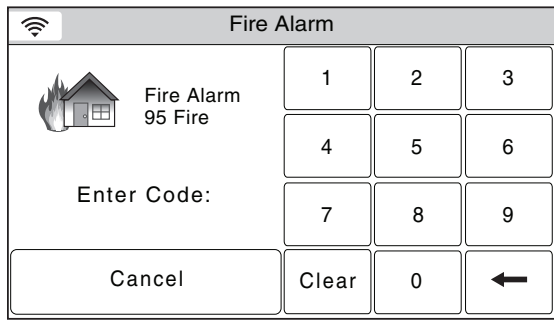

**Note:** Dependent upon how your system has been programmed a keypad may be displayed. This will allow you to cancel the alarm by entering valid User Code on the keypad.

### Chime Mode

Your system can be set to provide you with an audible alert of the opening of a door, while it is disarmed, by using Chime mode. When activated, three beeps or a programmed chime will sound at the control whenever a protected perimeter door is opened and the zone voice descriptor will be announced, if programmed. The Chime mode can be changed only when the system is disarmed. Additionally, the faulted zone information will be displayed on the Security Screen. Selecting the “Zones” icon displays the open protection points.



**The chime feature is intended for convenience and is not intended for Life Safety purposes or for use as a pool alarm and does not meet the requirements of UL2017.**

### Turning Chime Mode On or Off

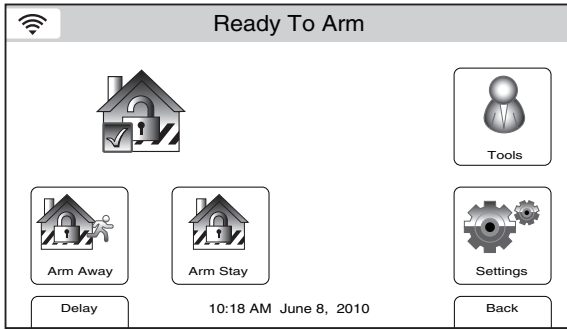

1. With the system in the disarmed state, select the “Settings” icon from the second page of the Security Screen. The system displays the Settings screen.

**Note:** The Settings Screen display is variable dependent upon the features that have been programmed in your system.

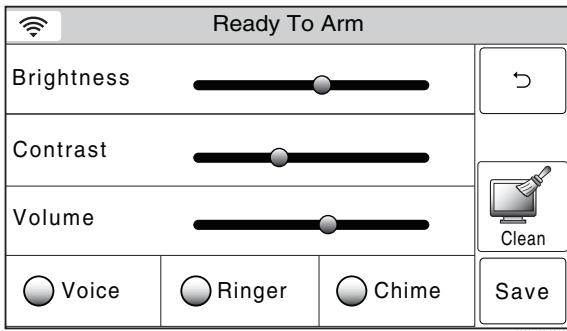

2. Select the “Chime” icon. The system toggles between “Off” and “On”, and when selected the button turns green. When “On” is selected, the Chime mode will be active.
3. Select the “Save” button to save your new settings.
4. Select the ↶ icon to return to the Security Screen.

### Selecting Chime Sounds

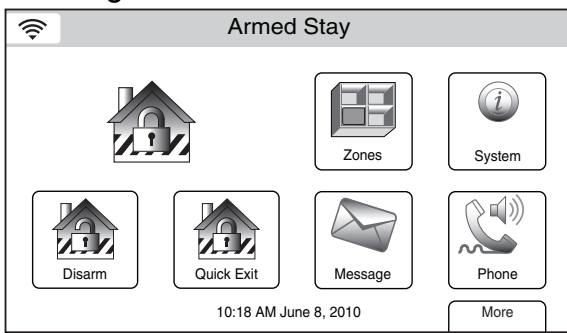

1. With the system in the disarmed state, select the “Zones” icon from Security Screen. The system displays the Zones screen.
2. Select the “Select All” button and scroll through the options until “Select Chime” button appears.

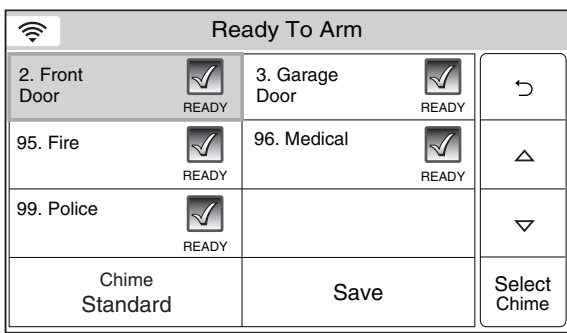

3. Select the applicable zone from the displayed list and then select the “Chime” button to scroll through the available chimes. Each chime sounds when selected.
4. Select the “Save” button to save your new settings.
5. Enter the Master User code on the displayed keypad.
6. The system returns to the Security Screen.

# SECURING THE PREMISES

## Voice Mode

### Voice Mode

Your system can be set to provide you with a voice alert of system functions by activating the Voice mode. When activated, the system will announce the system status when armed/disarmed.

### Turning Voice Mode On or Off

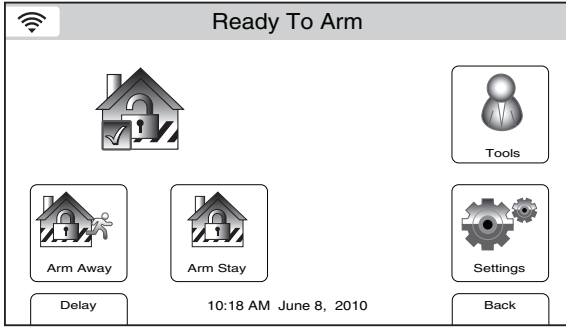

1. With the system in the disarmed or armed state, select the "Settings" icon from the second page of the Security Screen. The system displays the Keypad screen.

**Note:** The Settings Screen display is variable dependent upon the features that have been programmed in your system.

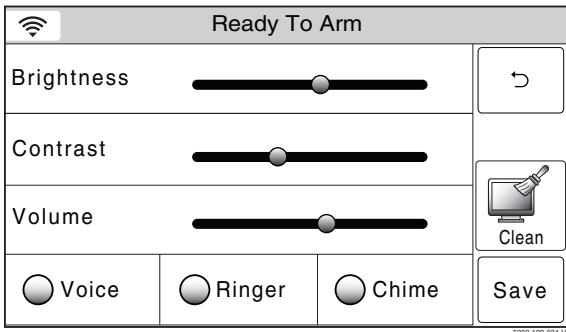

2. Select the "Voice" icon. The system will toggle between "Off" and "On", and when selected the button turns green. When "On" is selected, the Voice mode will be active.
3. Select the "Save" button to save your new settings and return to the Security screen.



### General Information

For additional security you (the Master User Code) can assign secondary user codes to individual users enabling them to perform specific system functions. These secondary users are identified by "User Numbers" when their codes are assigned. You can assign up to 30 user codes. Note that the Master User is the only one who can assign codes to secondary users.

All codes can be used interchangeably when performing system functions (a system armed with one user's code can be disarmed by another user's code), with the exception of the Guest Code described below.

- **Guest Code:** This code can be used to arm the system, but cannot disarm the system **unless** the system was armed with this code. This code is typically assigned to someone (such as a Guest) who needs to arm/disarm the system only at certain times.
- **Duress Code:** This feature is intended for use when you are forced to disarm or arm the system under threat. When used, the system will act normally, but can silently notify the alarm monitoring company of your situation, if that service has been provided. **The Duress Code is useful only when the system is connected to an alarm monitoring company.**

**IMPORTANT:** Temporary users of the system (e.g., Guests, cleaning staff) should not be shown how to use any system function they do not need to know, such as bypassing protection zones for example.

### Adding a User

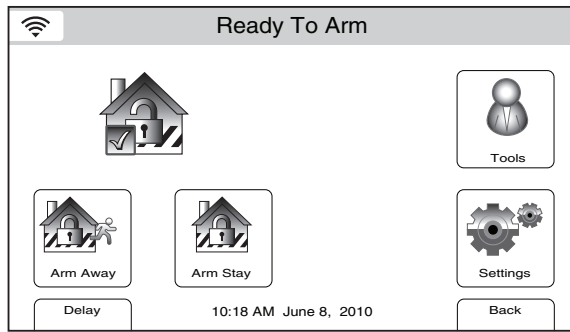

1. With the system in the disarmed state, select the "Tools" icon from the second page of the Security Screen. The system displays the Keypad screen.

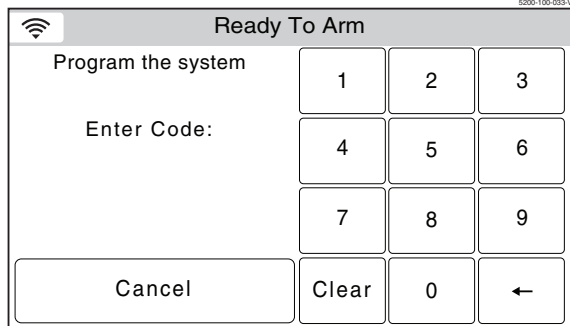

2. Enter your 4-digit Master User Code. The system displays the Master User programming screen.

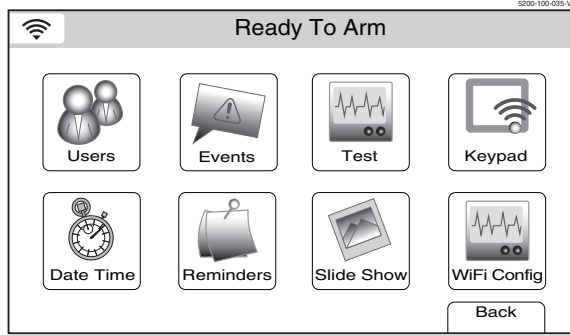

3. Select the "Users" icon. The system displays the Master User screen.

# USER FUNCTIONS

## User Access

Ready To Arm		
Master ****	Guest ****	↶
Duress ****		⬆
		⬇
Edit	Add New	Delete

5200-100-037-V0

Ready To Arm		
Name User 3	03	↶
User Code	Z-wave Lock Control No	
		Save

5200-100-038-V0

Ready To Arm										
123!@#	User3	↶								
Q	W	E	R	T	Y	U	I	O	P	
A	S	D	F	G	H	J	K	L		
Clear	Z	X	C	V	B	N	M			⬅
abc...										Done

5200-100-039-V0

Ready To Arm		
Name Thomas	03	↶
User Code ****	Z-wave Lock Control Yes	
Z-wave Unlocking Door Disarm		
		Save

5200-100-040-V0

Ready To Arm		
Master ****	Guest ****	↶
Duress ****	Thomas ****	⬆
		⬇
Edit	Add New	Delete

5200-100-041-V0

4. Select the “Add New” key. The system displays the User screen.

**Note:** \*\*\*\* Following a User name indicates that a valid 4-digit User Code has been assigned to the User.

5. Select the “Name” key, the system displays a keyboard.

**Note:** The Z-wave Lock Control option is only displayed if Z-Wave has been enabled.

6. If desired you can enter a User Name. Select the “Clear” key and then enter up to 10 characters of text.

**Note:** Select the “ABC...” key to switch the keyboard between upper/lower case or the “123!@#” key to switch to numbers.

7. Once you are finished, select “Done”. The system displays the Keypad screen.

8. Enter the 4-digit code for the new User followed by “Done”. The system returns to the Users Programming screen and the new User is displayed and along with \*\*\*\*.

9. If a Z-Wave door lock is installed, select the “Z-wave Lock Control” key to enable the User. The system toggles between “No” and “Yes”. When “Yes” is selected, the User Code will be synchronized with all enrolled Z-wave door locks allowing the same User Code to be used at the door locks.

**Note:** The number of User Codes supported by each door lock varies between manufacturers. To ensure compatibility, set the length of the Master User Code on the door lock to be greater than four digits.

10. If “Yes” is selected the system displays the “Z-wave Unlocking Door” key.

11. Select the “Z-wave Unlocking Door” key. The system toggles between “Disabled” and “Disarm”. When “Yes” is selected, entering a valid User Code with Z-wave Lock Control enabled at the door lock will disarm the system.

12. Once the User programming is complete select “Save”. The system returns to the Users screen and the new User is shown.

**Note:** \*\*\*\* Following a User name indicates that a valid 4-digit User Code has been assigned to the User.

### Editing/Deleting a User

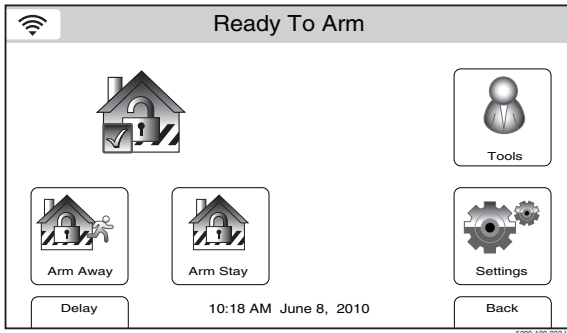

1. With the system in the disarmed state, select the “Tools” icon from the second page of the Security Screen. The system displays the Keypad screen.

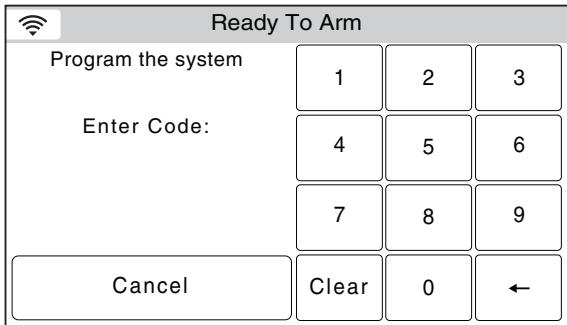

2. Enter your 4-digit Master User Code. The system displays the Master User programming screen.

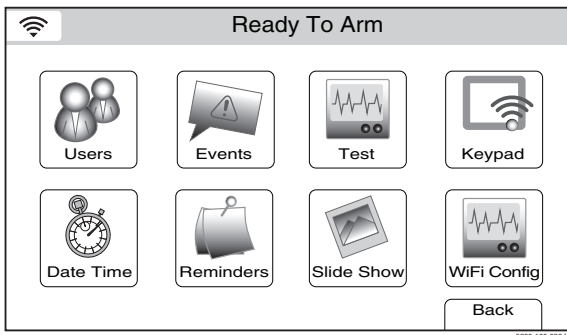

3. Select the “Users” icon. The system displays the Users screen.

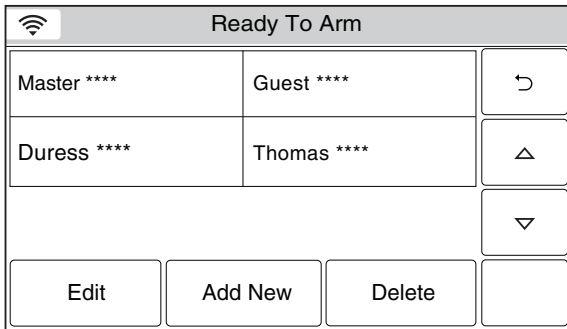

4. Select a User Name and then select “Edit” or “Delete”. If you are editing user information proceed to step 5. If you are deleting a user, proceed to step 8.

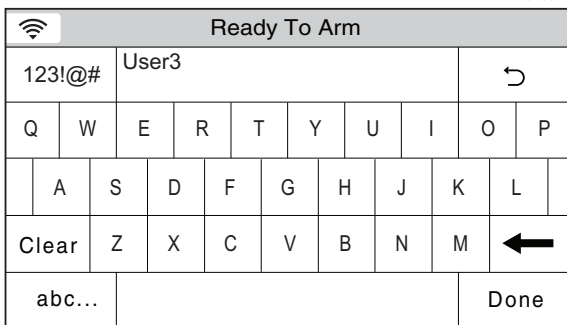

5. If desired you can revise a User Name. Select the “Clear” key and then enter the desired text.
6. Once you are finished, select “Done”. The system displays the Keypad screen. If you wish to change the assigned User Code, proceed to Step 7 otherwise proceed to Step 9.

# USER FUNCTIONS

## User Access

Ready To Arm			
User Code	1	2	3
	4	5	6
	7	8	9
	Clear	0	Done

5200-100-042-V0

7. If desired, enter a new 4-digit code for the selected User followed by "Done". The system returns to the Users screen.
8. Select "Yes" or "No" when the confirmation screen is displayed then proceed to step 9.
9. Select the ↶ icon to return to the Master User screen.

## View Events

This feature allows you to view System Events such as Arming/Disarming, Zone Activity, Troubles and Alarms.

### Viewing System Events

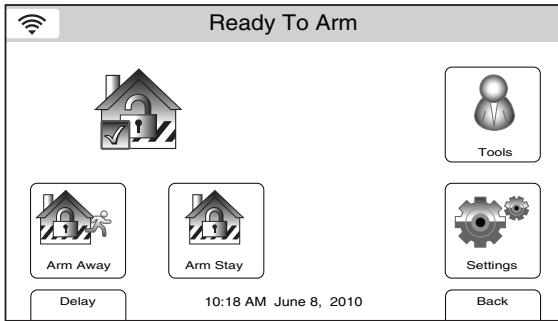

1. With the system in the disarmed state, select the “Tools” icon from the second page of the Security Screen. The system displays the Keypad screen.

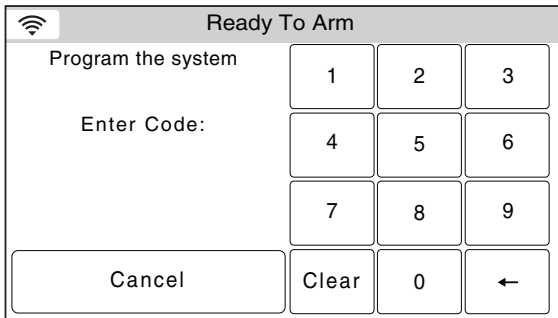

2. Enter your 4-digit Master User Code. The system displays the Master User programming screen.

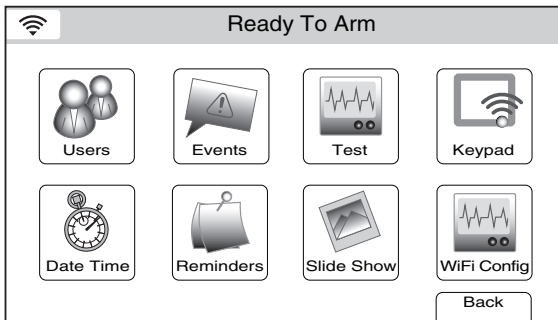

3. Select the “Events” icon. The Events screen will appear and displays all events.

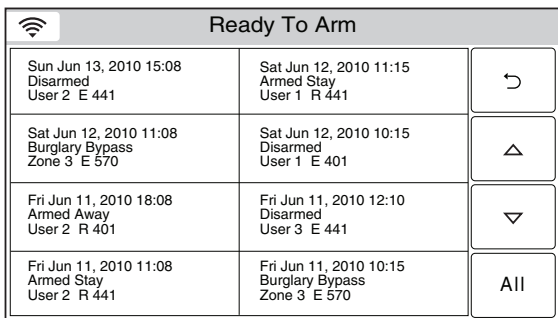

4. If you wish to view specific system history, select “All”. The system displays a new menu.

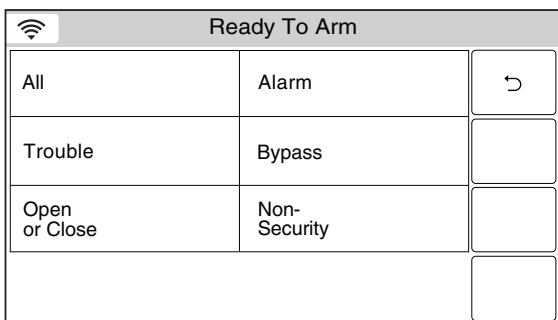

5. Select from the menu to display the specific event types that you wish to view.

**Note:** The Event Types that are displayed is variable dependent upon the options that were programmed by your installer.

# USER FUNCTIONS

## Message Recording and Playback

The LYNX Touch Message Center allows you to record, play and delete messages. The maximum message duration is 184 seconds.

- NOTES:** (1) If the system loses electrical power, all messages will be erased.  
(2) Message Play/Record will not be available if a report must be sent.

### Entering Message Mode

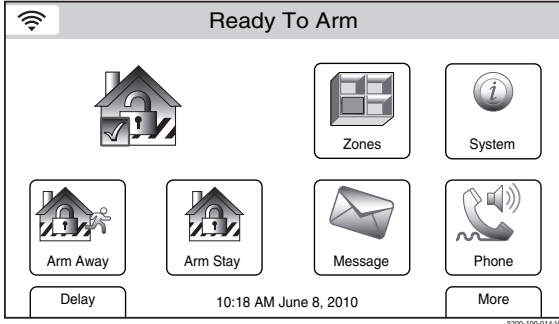

1. With the system in the disarmed state, select the “Message” icon from the Security Screen. The system displays the Message screen.

### Recording a Message

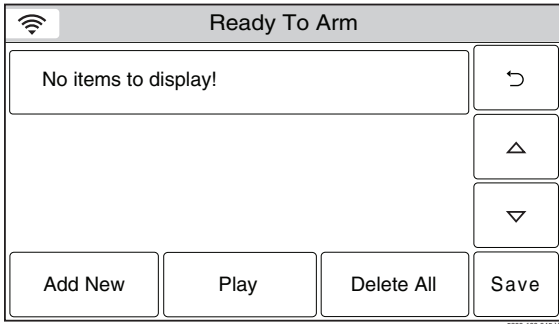

1. Select “Add New”. The system displays the Record Message screen.

**Note:** The System will display the total message recording time available.

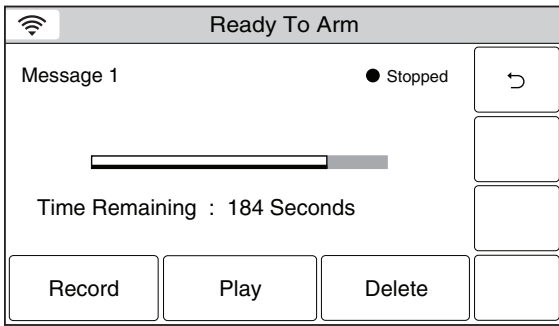

2. Select “Record”, the system sounds a single tone. Speak into the microphone and record your message.
3. When you are finished recording your message, select. “Stop”
4. To listen to the message, select “Play”.
5. If you wish to delete the message, select “Delete”.
6. Record additional messages as required.



6. When you have finished recording, select “↶”. The system displays the recorded messages.
7. To record additional messages (if recording time is available) repeat steps 1 through 3.

**NOTE:** If you are trying to record a new message and the message center is already full, “Add New” will not be displayed. If the message center is full all old messages must be deleted before new messages can be recorded. See the *Deleting Messages* section.

## Message Recording and Playback

### Playing Message(s)



1. At the Message screen, select the message you wish to play.
2. Select "Play", the system plays your message.
3. When you are finished listening to the message, you may select. "Stop". If "Stop" is not selected the system continues to play the remaining messages.
4. When you have finished listening to the messages, select "⏪". The system returns to the Security Screen.

### Deleting Messages



1. At the Message screen, select "Delete All". The system deletes all messages.
2. When you have finished deleting the messages, select "⏪". The system returns to the Security Screen.

# USER FUNCTIONS

## System Settings

The volume level of message playback, system announcements, and status beeps can be changed if desired. Additionally, you can adjust the display's brightness and contrast and turn on or off the Chime or turn off the telephone Ringer.

### Change System Settings

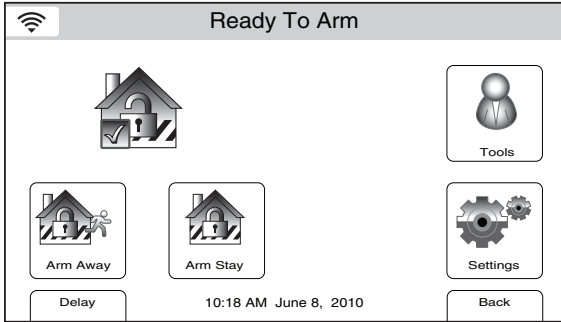

1. With the system in the disarmed or armed state, select the "Settings" icon from the second page of the Security Screen. The system displays the Settings screen.

**Note:** The Settings Screen display is variable dependent upon the features that have been programmed in your system.

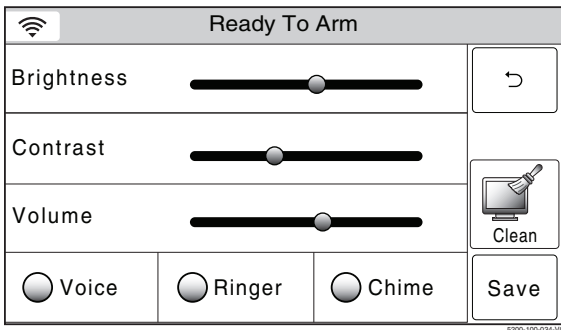

2. Increase or decrease the Display Brightness or Contrast or the System Volume by using the sliding adjustment from left (decrease) to right (increase).
3. Turn the Voice, Chime or telephone Ringer On or Off by selecting the appropriate icon. The system toggles between "On" and "Off", and when selected the button turns green.
4. Select "Save" when you are finished. The system returns to the second page of the Security Screen.



If your system is equipped with a GSM or Internet Communication Module, the time and date will be programmed and updated automatically via Central Station. You may still program the correct Time Zone as shown below. Check with your installer to see if your system is equipped with a Communications Module.

### Setting the Date and Time

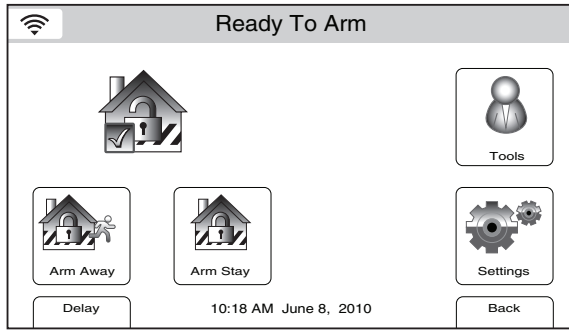

**Note:** The system must be disarmed in order to set the date and time.

1. With the system in the disarmed state, select the "Tools" icon from the second page of the Security Screen. The system displays the Keypad screen.

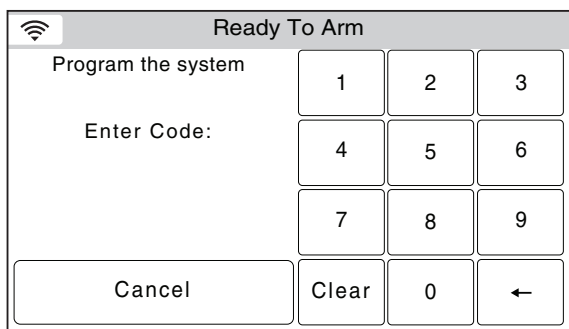

2. Enter your 4-digit Master User Code. The system displays the Master User programming screen.

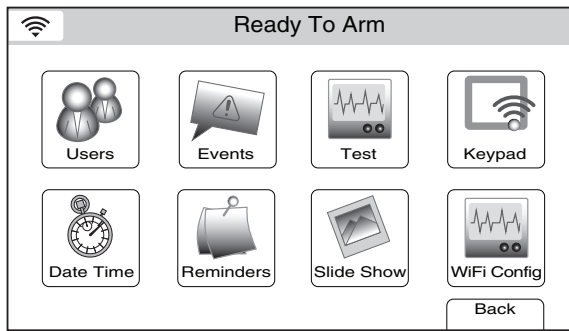

3. Select the "Date Time" icon. The Calendar screen will appear.

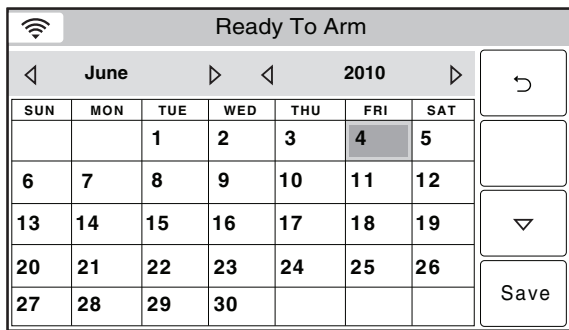

4. Select the correct month by using the "◀" and "▶".
5. Select the correct year by using the "◀" and "▶".
6. Select the correct day on the calendar.
7. When you have finished select the "▼" icon. The system advances to the time screen.

# USER FUNCTIONS

## Clock/Calendar

Ready to Arm ...				
Enter Time 10:21 AM  AM / PM	1	2	3	↶
	4	5	6	▲
	7	8	9	▼
	Clear	0	←	Save

5200-100-048 V0

Ready To Arm		
Time Zone <b>Eastern (EST)</b>		↶
Day Light Savings Time <b>Yes</b>		▲
Start Month <b>March</b>	Start Week <b>Second</b>	
End Month <b>November</b>	End Week <b>First</b>	Save

5200-100-050 V0

Ready To Arm		
January	February	↶
March	April	▲
May	June	▼
July	August	

5200-100-051 V0

8. If the displayed time is not correct, select “Clear” then enter the correct time (4 digits) on the keypad and select AM or PM.
9. When you have finished select the “▼” icon. The system advances to the next screen OR proceed to step 17.

10. Select “Time Zone”. The system scrolls between through the following options:
  - Eastern (EST)
  - Central (CST)
  - Mountain (MST)
  - Pacific (PST)
  - Hawaii (HAST)
  - Alaska (AKST)
  - Brasilia (BRT)
  - Mid-Atlantic (MAT)
  - Atlantic (AST)
  - Newfoundland (NT)

Select the correct time zone.

11. Select “Day Light Savings Time”. The system toggles between “Yes” and “No”.

**Note:** The start month/week and end month week are default programmed to “March/Second” and “November/First” respectively. Steps 13 to 16 should only be performed if you wish to change those entries. If you are not changing the defaults, advance to step 17.

12. Select “Start Month”. The system displays a calendar. Select the correct month.

13. Select “Start Week”. The system will toggle between:
  - Second
  - Third
  - Fourth
  - Last
  - Next to Last
  - 3rd from Last
  - First

14. Select “End Month”. The system displays a calendar. Select the correct month.

15. Select “End Week”. The system will toggle between:
  - First
  - Second
  - Third
  - Fourth
  - Last
  - Next to Last
  - 3rd from Last

16. When you are finished select the “Save” key. The system returns to the Master User program screen.

If your system is equipped with a GSM or Internet Communication Module, but is not subscribed to TotalConnect Services it can be programmed to receive single day weather information. If an Internet Communication Module is installed the the weather updates every 4 hours during the 3, 7, 11 am/pm hours (local time). If a GSM Communication Module is installed the weather updates twice daily at 12 am/pm local time. Check with your installer to see if this option is available.

**Important:** To ensure you get accurate weather forecasts you must enter as much location information as possible. This is especially important in more rural areas where the ZIP/Postal code covers a wide region.

### Enable Single Day Weather Reporting

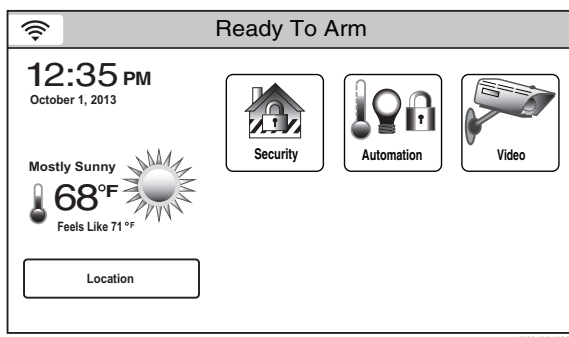
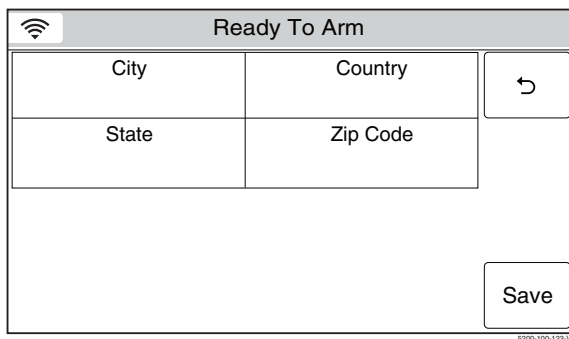
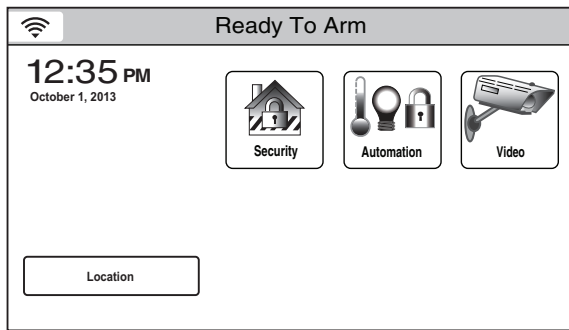

1. At the Home Screen, select the “Location” button. The system advances to the Location Screen.
  2. Select “City” and enter the required information on the displayed keypad. The city must be spelled properly. It should contain spaces where required. (i.e., “new york city”). Select “Done” when finished.
  3. Select “Country” and enter the required information on the displayed keypad. When entering the country, use the following codes: United States = “US” Canada = “CA”. Select “Done” when finished.
  4. Select “State” and enter the required information on the displayed keypad. When entering the State or Province, be sure to use the proper 2-character State/Possession or Province/Territory abbreviation. Select “Done” when finished.
  5. Select “Zip Code” and enter the required information on the displayed keypad. Enter the correct five digit US zip code or six character Canadian postal code. Do not insert any spacing in the entry. Select “Done” when finished.
  6. Select “Save” when all fields are complete.
- Notes:** For a list of US State/Possession standard abbreviations go to: <http://pe.usps.com/text/pub28/28apb.htm>.  
For a list of Canadian Province/Territory standard abbreviations go to: [http://pe.usps.com/text/pub28/28apa\\_005.htm](http://pe.usps.com/text/pub28/28apa_005.htm)
7. The Home Screen is displayed within a few minutes and local weather will appear.

# USER FUNCTIONS

## Automation

### General Information

Automation is used to program triggers, send Follow-Me or E-mail messages of system events or program home automation features (Z-Wave) including Rules and Scenes (if Z-Wave communications have been enabled). Up to 40 rules can be programmed. Rules 1 through 20 are used for Triggers, Z-Wave Scenes and Follow-Me Messages. Rules 21 through 40 are used for Z-Wave Scenes and for E-mail notification and are only accessible through TotalConnect Service. Check with your Installer to see which options are available to you.

**Note:** Switches, Thermostats, Locks, Water Valves, Tools, and Scenes options will only appear when Z-wave has been enabled. Refer to the Home Automation Guide P/N 800-16091 for information regarding these features.

### Schedules

The Schedules Feature can be used to program the system to automatically perform certain functions (i.e.; automatically arming the system in Stay mode and activating output [Z-Wave] devices) at a scheduled time, day of the week or month, as applicable.

### Programming a Scheduled Function

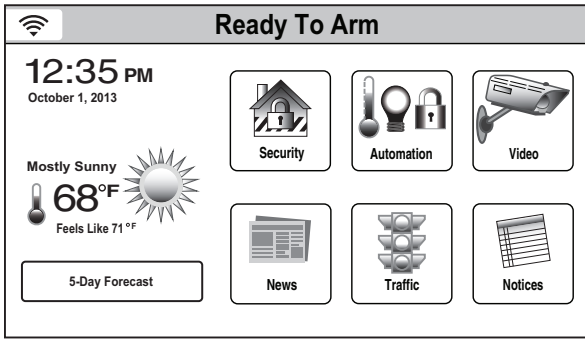

1. With the system in the disarmed state, select the "Automation" icon from the Home Screen. The system displays the first page of the Automation screen. Select the select the "▼" icon to advance to the second page of the Automation screen.

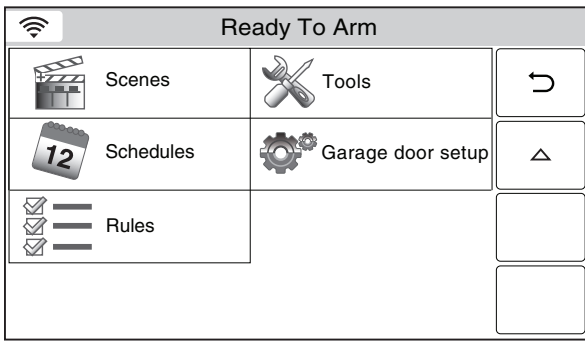

2. Select the "Schedules" icon. The system displays the Scheduling screen.  
**Note:** Rules 21-40 are only accessible through TotalConnect Service.

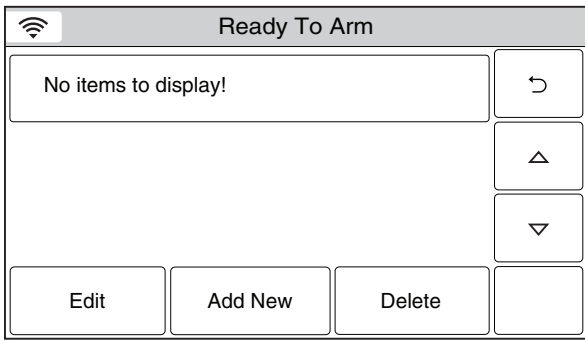

3. Select "Add New". The system displays the scheduling options screen.

**Automation**

Ready To Arm		
Name	Frequency <b>None</b>	↶
Type <b>None</b>		
Location		Save

5200-100-057-V0

Ready To Arm		
City	Country	↶
State	Zip Code 0	
		Save

5200-100-061-V0

Ready To Arm		
Name <b>Lights</b>	Frequency <b>Daily</b>	↶
Type <b>Scene</b>	Scenes	
Start Time <b>12:00 AM</b>	Time Randomization <b>No</b>	
		Save

5200-100-114-V0

4. Select "Name". The system displays a keypad.
5. Enter a name (up to 13 digits long) for the scheduled function on the displayed keypad then select "Done".
6. Select "Type" then scroll through and select one of the following options:
  - None
  - Auto Night Stay (displayed if Arm Night zone is enabled)
  - Auto Stay
  - Rules
  - Disarm Notification
  - Scene
7. Select "Frequency" then select one of the following displayed options:
  - None
  - Once
  - Daily
  - Weekday
  - Weekly
  - Monthly
  - Sunrise
  - Sunset

If Sunrise or Sunset is selected, the Type option defaults to "Scene". Select "Location" and proceed to step 8, otherwise proceed to step 9. If Total Connect Services are enabled and Sunrise or Sunset is selected, the Type option defaults to "Scene". Proceed to step 13.
8. Select "City", "Country", "State" and "Zip Code" and enter the required information on the displayed keypad then select "Done". Select "Save" when all fields are complete. (Refer to the *Enable Single Day Weather Reporting* section for additional information regarding programming these fields.) Proceed to step 13.
9. Program the options below, based upon the Type selected in Step 6 and the Frequency selected in step 7 or if "Scene" is selected proceed to Step 13.
  - Once            Start Time/End Time/ Date
  - Daily           Start Time/End Time
  - Weekday       Start Time/End Time
  - Weekly         Start Time/End Time/Day of the Week
  - Monthly        Start Time/End Time/Day of the Month
10. Select "Rules" then select a Rule from the displayed list (Rules 1 through Rules 20).
11. Enter a Start Time and End Time on the displayed keypad then select "Save".
12. Select the "↶" button to return to the Automation programming screen or the Home key to return to the Home Screen.
13. Select "Scenes". Select the desired scene from the displayed list.
14. Enter a Start Time and End Time on the displayed keypad then select "Done".
15. If "Daily", "Weekday", "Weekly" or "Monthly" was selected for "Frequency", the Randomization field is displayed. Select "Randomization", the system toggles between "No" and Yes".
 

**Note:** If using the Randomization feature scheduled events should not be programmed within one hour of each other.
16. Select "Save". The system displays to the list of programmed Schedules.
17. Select the "↶" button to return to the Automation programming screen or the Home key to return to the Home Screen.

# USER FUNCTIONS

## Automation

### Editing a Scheduled Function

Ready To Arm		
Schedule 1 Auto Stay	Auto Arm Daily	↶
		▲
		▼
Edit	Add New	Delete

5200-100-084-V0

1. At the Schedules screen, select the Schedule you wish to edit.

**Note:** Rules 21-40 are only accessible through TotalConnect Service.

2. Select the “Edit” button. The Schedule programming screen will appear. Follow the steps as noted above in the programming a Scheduled Function section to edit and save your changes.

### Deleting a Scheduled Function

Ready To Arm		
Schedule 1 Auto Stay	Auto Arm Daily	↶
		▲
		▼
Edit	Add New	Delete

5200-100-084-V0

1. At the Schedules screen, select the Schedule you wish to delete.

**Note:** Rules 21-40 are only accessible through TotalConnect Service.

2. Select the “Delete” button. A confirmation screen will be displayed. Select “Yes” to confirm the deletion.

3. Select the “↶” button. The system returns to the Automation programming screen.

### Rules

Up to 40 rules can be programmed. Rules 1 through 20 are used for Triggers, Z-Wave Scenes and Follow-Me Messages. Rules 21 through 40 are used for Z-Wave Scenes and for E-mail notification and are only accessible through TotalConnect Service. Check with your Installer to see which options are available to you.

The following options are programmed in this section:

Programming Field	Action
Rule 1 - 20:	Select Rule 1 -20 <b>Note:</b> Rules 21-40 are only accessible through TotalConnect Service.
Name:	Name the device
Type:	Select the output type
Action:	Select the action required for the device
Start Zone Type:	Select Zone Type to start event
Stop Zone Type:	Select Zone Type to stop event
Start System Operation:	Select System Operation to start event
Stop System Operation:	Select System Operation to stop event
Zone Number Operation:	Select Zone Number to trigger event upon fault, trouble or alarm as selected.

### Programming Rules

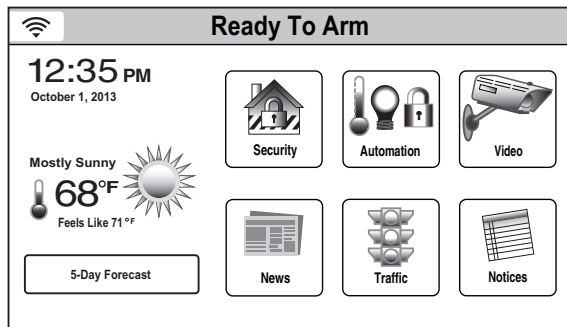

1. With the system in the disarmed state, select the “Automation” icon from the Home Screen. The system displays the first page of the Automation screen. Select the “▼” icon to advance to the second page of the Automation screen.

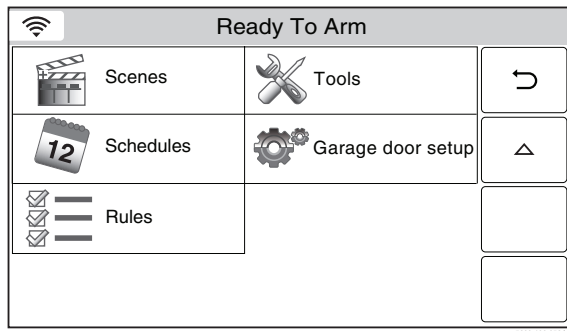

2. Select the “Rules” button. The system displays the Rules screen.

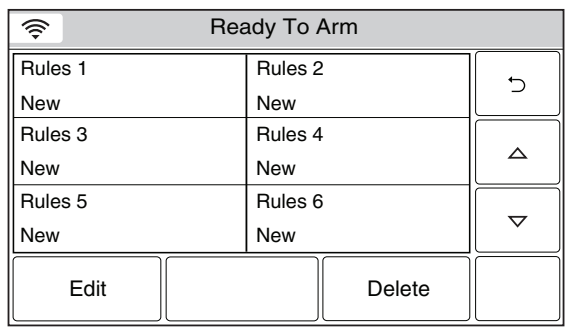

3. Select a “Rules” key followed by the Edit button. **Note:** Rules 21-40 are only accessible through TotalConnect Service.

# USER FUNCTIONS

## Automation

Ready To Arm												
123!@#											↶	
Q	W	E	R	T	Y	U	I	O	P			
A	S	D	F	G	H	J	K	L				
Clear	Z	X	C	V	B	N	M	←				
abc...											Done	

Ready To Arm		
Name	01	↶
Type Disabled		
		▼
		Save

Ready To Arm		
Name	01	↶
Type Trigger Output	Action None	
Start Zone Type Not Used	Stop Zone Type Not Used	▼
Start System Operation Not Used	Stop System Operation Not Used	Save

4. Select the “Name” key and then enter up to 13 characters of text on the displayed keyboard to assign a name to the Rule.

**Note:** Select the “ABC...” key to switch the keyboard between upper/lower case or the “123!@#” key to switch to numbers.

5. Once you are finished, select “Done”. The system returns to the Rules screen.

6. Select the “Type” button. Dependent upon the features programmed in your control, the system toggles between the following Types:

- Disabled
- Trigger Output
- Scene (displayed when Z-Wave has been enabled)
- To Ph. 1 (Message to Phone 1)
- To Ph. 2 (Message to Phone 2)
- To Ph. 1 & 2 (Message to Phone 1 & 2)
- Email 1

The system displays several new programming fields, dependent upon the Type that is selected.

If Scene was selected, refer to the Home Automation Guide P/N 800-16091 for information.

7. Select “Action”. Dependent upon the Type selected previously, the system scrolls between several options:

- None
- Permanent On
- On for 2 sec
- Pulsing
- Send
- Run Scene\*

\* If Scene was selected in step 6 refer to the Home Automation Guide PN 800-16091 for information.

8. Select “Start Zone Type”. Use the “▲” “▼” buttons to scroll to second and third page of zone type options. The system displays the following options (dependent upon the Type that was selected).

- |                     |                      |
|---------------------|----------------------|
| Not Used            | Entry Exit 1         |
| Entry Exit 2        | Perimeter            |
| Interior Follower   | Day / Night          |
| 24 Hour Silent      | 24 Hour Audible      |
| Silent Burglary     | 24 Hour Auxiliary    |
| Interior With Delay | Fire No Verification |
| Carbon Monoxide     | Trouble              |
| No Response         | Arm Stay             |
| Arm Away            | Disarm               |
| Monitor             | Resident Monitor     |
| Resident Response   | General Monitor      |
| General Response    | Garage Door          |
| Garage Monitor      |                      |



**Automation**

Ready To Arm		
Name	01	↶
Type	Action	
Trigger Output	None	
Start Zone Type	Stop Zone Type	▼
Not Used	Not Used	
Start System Operation	Stop System Operation	Save
Not Used	Not Used	

9. Select “Stop Zone Type” The system displays the same options as the previous step.

**Note:** If a Rule is being used to trigger a Z-Wave door lock, when the system is Armed Stay or Armed Away, it is recommended that “End of Exit Delay” be selected for System Operation 1 or System Operation 2.

10. Select “Start System Operation”. Use the “▲” “▼” buttons to scroll to second page of zone type options. The following options are displayed:

- |                      |                   |
|----------------------|-------------------|
| Not Used             | Arm Stay          |
| Arm Away             | Disarm            |
| Any Burglary Alarm   | Any Fire Alarm    |
| Bell Timeout         | End of Exit Delay |
| Start of Entry Delay | Chime             |
| Kissoff              | Bypass            |
| System Low Battery   | Reporter Failure  |
| Duress Alarm         |                   |

11. Select “Stop System Operation”. The system displays the same options as step 10.

Ready To Arm	
Zone Number Operation	↶
Not Used	▲
	Save

12. Select “Zone Number Operation”. The system toggles between the following options:

- Not Used
- Fault
- Trouble
- Alarm

**Notes:** 1. For Fault, the following zone types should not be used: General Monitor, General Response, Resident Monitor, and Resident Response.

2. When a zone has been deleted, please verify the programming selection for Zone Number Operation.

If Trouble, Fault or Alarm is selected, the system displays several new options. Proceed to Step 13.

Ready To Arm		
Zone Number Operation		↶
Fault		
First Start Zone	First Stop Zone	▲
Disabled	Disabled	
Second Start Zone	Second Stop Zone	
Disabled	Disabled	
Third Start Zone	Third Stop Zone	Save
Disabled	Disabled	

13. Select the First, Second or Third “Start Zone” Select the Zone from the list displayed by the system.

14. Select the First, Second or Third “Stop Zone” Select the Zone from the list displayed by the system.

15. Select “Save” when programming is complete.

16. Select the “↶” button. The system returns to the Automation programming screen.

# USER FUNCTIONS

## Automation

### Editing or Deleting Rules

Ready To Arm		
Device 1 System Armed Follow Me	Device 2 New	↶
Device 3 New	Device 4 New	⬆
Device 5 New	Device 6 New	⬇
Edit		Delete

Ready To Arm		
Name System Armed	01	↶
Type Message to phone 1	Action Send	
Start Zone Type Not Used	Stop Zone Type Not Used	⬇
Start System Operation Armed Stay	Stop System Operation Disarm	Save

1. At the Rules Programming Screen, select the Rule that you wish to edit or delete.

**Note:** Rules 21-40 are only accessible through TotalConnect Service.

2. To delete the rule, select the Delete button. To edit the rule select the Edit button and proceed to step 3.

3. Select the field that you wish to edit and follow the steps as outlined in the Programming Rules procedure.

## Reminders

The Reminder Feature can be used to program/record reminders that can be displayed on the touch screen, announced by the control and/or sent to one or two pre-programmed phone number(s). Check with your installer to see if the latter feature has been programmed on your control.

### Programming a Reminder

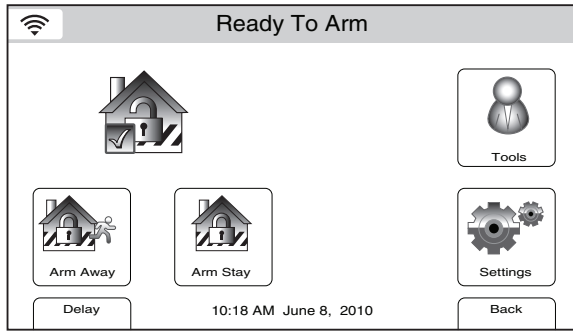

1. With the system in the disarmed state, select the “Tools” icon from the second page of the Security Screen. The system displays the Keypad screen.

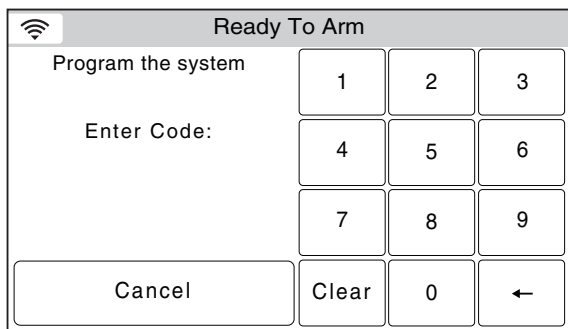

2. Enter your 4-digit Master User Code. The system displays the Master User programming screen.

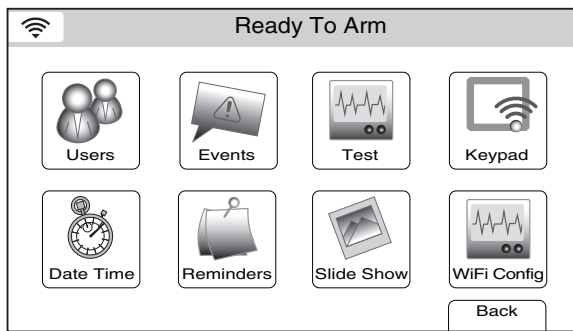

3. Select the “Reminders” icon. The system displays the Reminders screen.

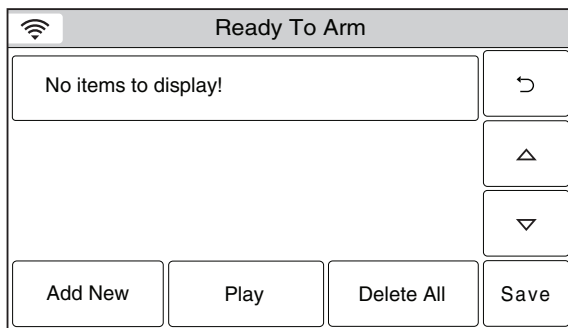

4. Select “Add New”. The system displays the Reminder programming screen.

# USER FUNCTIONS

## Reminders

Ready To Arm		
Name	Frequency <b>None</b>	↶
Voice <b>No</b>	Acknowledge <b>No</b>	Save

5200-100-068-V0

Ready To Arm									
123!@#		↶							
Q	W	E	R	T	Y	U	I	O	P
A	S	D	F	G	H	J	K	L	
Clear	Z	X	C	V	B	N	M	←	
abc...		Done							

5200-100-069-V0

Ready To Arm		
Reminders 1	● Stopped	↶
<div style="border: 1px solid black; width: 100px; height: 10px; margin: 0 auto;"></div>		
Record	Play	Delete

5200-100-070-V0

Ready To Arm		
Name <b>Walk Dog</b>	Frequency <b>Once</b>	↶
Date <b>January 1, 2011</b>		
Start Time <b>3:00 PM</b>		
Voice <b>No</b>	Follow Me <b>Disabled</b>	Acknowledge <b>No</b>
		Save

5200-100-071-V0

5. Select "Name". Enter a name for the scheduled function on the displayed keypad then select "Done".
6. Select "Frequency" then select one of the following displayed options:
 

None	Once
Daily	Weekday
Weekly	Monthly
7. Program the following options based upon the Frequency selected in step 6:
 

Once	Date/Start Time
Daily	Start Time
Weekday	Start Time
Weekly	Day of the Week/Start Time
Monthly	Day of the Month/Start Time
Sunrise	Day of the Week/Start Time
Sunset	Day of the Week/Start Time
8. If a voice reminder is desired, select "Voice". The system toggles between "No" and "Yes". If yes is selected, the record reminders screen appears.
9. Select the "Record" button and record your reminder. When you are finished select the "Stop" button followed by the "↶" button. The system returns to the Reminder programming screen.
10. If a "Follow Me" phone number(s) was programmed by your installer you can send a reminder to the phone number(s). Select "Follow Me" option. The system toggles between "Disabled", "To Ph. 1", "To Ph. 2" and "To Ph. 1 & 2", as applicable.
 

Note: For important reminders you should program the "Acknowledge" option. When this option is selected, the reminder will continue to play until it is acknowledged.
11. Select the "Acknowledge" option. The system toggles between "No" and "Yes".
12. Select "Save" when all applicable options have been programmed.

### Editing a Reminder

The screenshot shows a mobile application interface titled "Ready To Arm". At the top left is a Wi-Fi icon. Below the title bar, there is a list item "Walk Dog - Daily" with a right-pointing arrow icon to its right. Below this list item are three vertically stacked buttons: an up arrow, a down arrow, and a square button. At the bottom of the screen are three buttons labeled "Edit", "New", and "Delete". A small text "5200-100-072-V0" is visible at the bottom right of the screen.

1. At the Reminders screen, select the reminder you wish to edit.
2. Select the "Edit" button. The Reminder programming screen will appear. Follow the steps as noted above in the programming a Reminder section to edit and save your changes.

### Deleting a Reminder

The screenshot shows a mobile application interface titled "Ready To Arm". At the top left is a Wi-Fi icon. Below the title bar, there is a list item "Walk Dog - Daily" with a right-pointing arrow icon to its right. Below this list item are three vertically stacked buttons: an up arrow, a down arrow, and a square button. At the bottom of the screen are three buttons labeled "Edit", "New", and "Delete". A small text "5200-100-072-V0" is visible at the bottom right of the screen.

1. At the Reminders screen, select the reminder you wish to delete.
2. Select the "Delete" button. A confirmation screen will be displayed. Select "Yes" to confirm the deletion.
3. Select the "↩" button. The system returns to the Master User programming screen.

# USER FUNCTIONS

## WiFi Configuration

### View/Join Available WiFi Networks

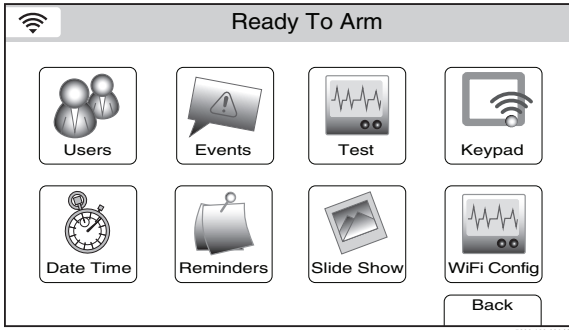

1. At the Master User screen select the WiFi Config icon. The system displays the WiFi options screen.

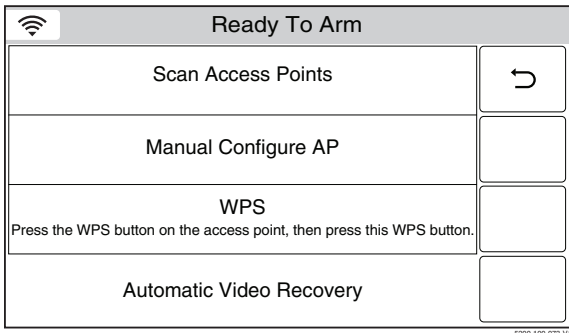

2. Select the "Scan Access Points" button to view the available networks. The available networks are displayed. Use the down ▼ arrow to scroll to the next page of options. Use the ▲ arrow to return to the previous page.

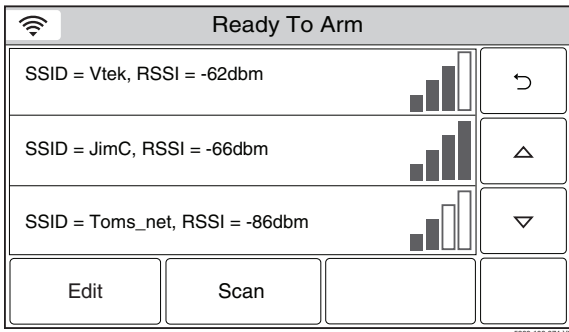

3. Select the desired Network and then select the "Edit" button. The network information is displayed. If a password is required, select the "Key" button and enter the password.

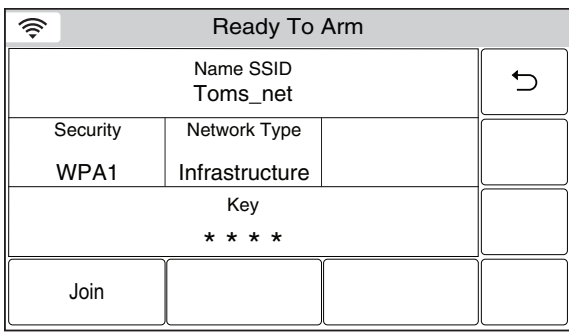

4. Select the "Join" button. A confirmation screen will be displayed.
5. Select the "Save" button, then select the "↶" button as required to return to the Master User screen.

### Manually Configure Access Point

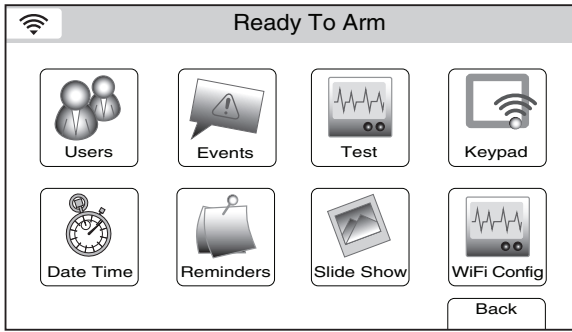

1. At the Master User screen select the WiFi Config icon. The system displays the WiFi options screen.

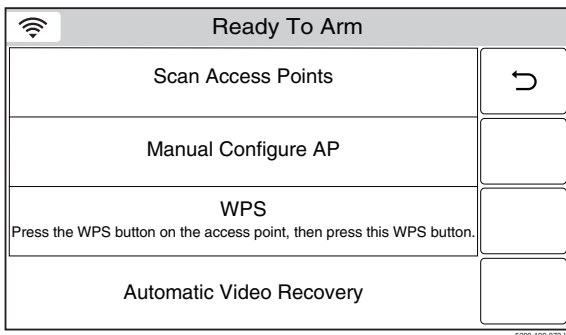

2. Select the “Manually Configure AP” button to view the available networks. The WiFi enrollment screen is displayed.

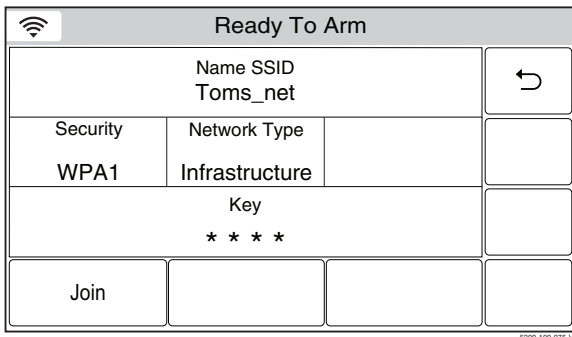

3. Select the “SSID Name” button and enter Network name on the displayed keypad.
  4. Select the “Security” button and select from “Open”, “WPA1”, “WPA2” and “WEP”. The network information is displayed. If a password is required, select the “Key” button and enter the password.
- Note:** When configuring for WEP encryption key on the access point, always use hexa-decimal type as the input method on the panel. The input key should contain characters such as 0-9 and A-F.
4. Select the “Join” button. A confirmation screen will be displayed. Select “OK”, then select “Save” to confirm the selection.
  5. Select the “↶” button as required to return to the Master User screen.

# USER FUNCTIONS

## WiFi Configuration

### Join a WPS (WiFi Protected Setup) Network

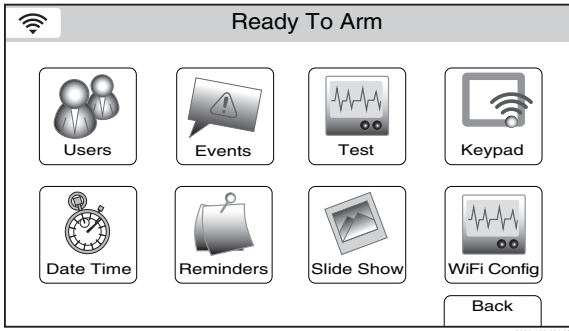

1. At the Master User screen select the WiFi Config icon. The system displays the WiFi options screen.

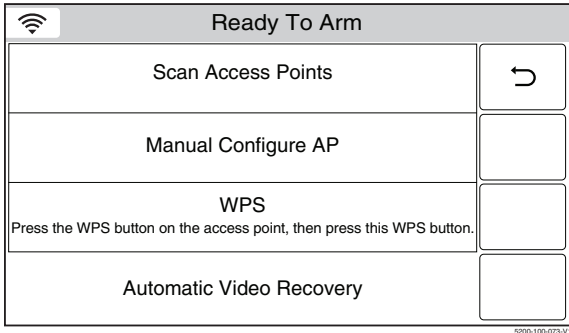

**Note:** For WPS operation, press the WPS button on the access point (router) first. Then press the WPS button on the control.

2. Select the “WPS” button. The system displays “Please Stand-by for WPS Operation...”
3. If the operation is successful, the system displays “Device has been successfully added to the network.” If the operation is unsuccessful the system displays “Failed Operation. Device not added to the network.”
4. Select “OK”.

### Enrolling/Syncing Auxiliary Keypads



**A router is required if you are using an approved mobile device as an Auxiliary Keypad. The router must be powered on and connected for WiFi operation to occur.**

The LYNX Touch will support up to four Mobile Devices (or tablets) that can be used as Auxiliary Keypads. A WiFi communication device and router are required. The “Keypad” button is used to enroll/sync the mobile device with the control. Refer to the documentation provided with the device to enroll/sync the keypad.

### Viewing or Deleting Enrolled Keypads

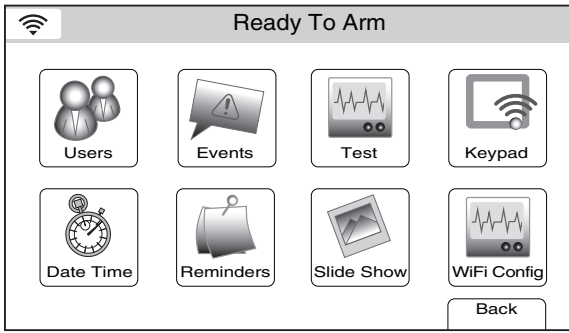

1. At the Master User screen select the Keypad icon. The system displays the WiFi devices screen.

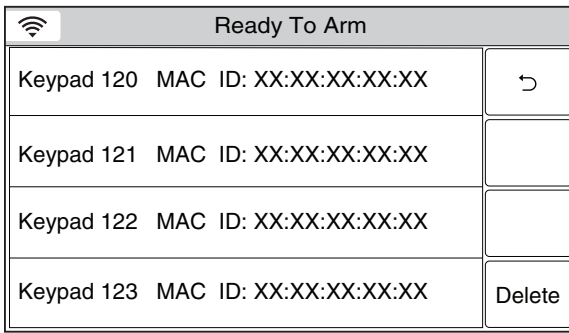

2. To delete a mobile device (auxiliary keypad) select the keypad to be deleted.
3. Select the “Delete” button.

**Note:** Defaulting the system will not automatically delete any associated keypads.



## Video Camera Control Feature

The LYNX Touch L5200 supports up to 20 video cameras and provides the capability to view live video from a single Camera. The installation of a WiFi or Internet Communications module and an internet connection are required. Check with your installer to see if this feature is available.

### Selecting a Camera

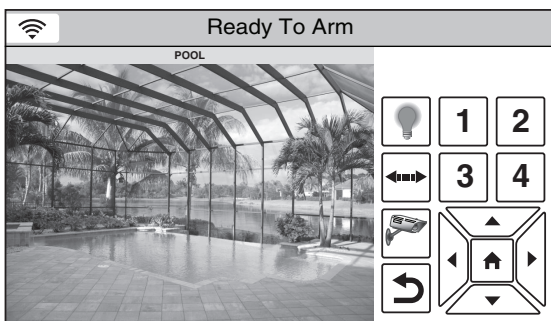
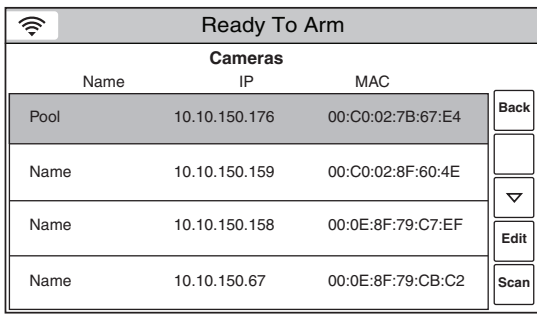
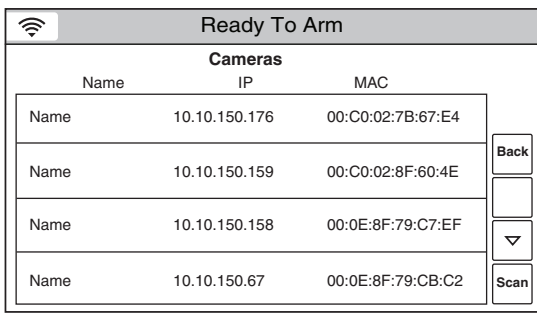
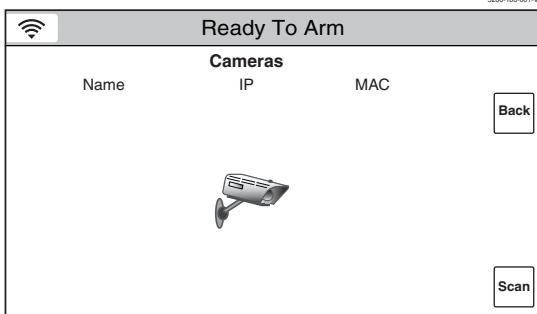
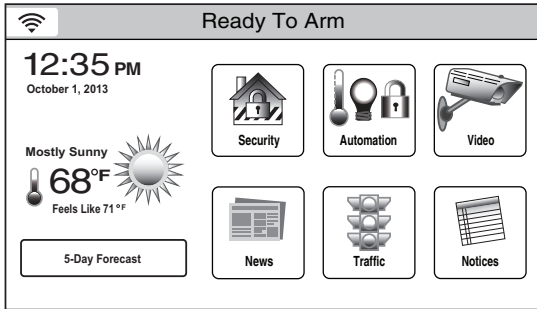

1. With the system in the disarmed or armed state, select the Video icon. The system advances to Cameras screen
2. If no cameras have been discovered or if a list of discovered cameras is invalid, a Camera scan will start automatically.  
**Note:** The latter can occur if a WiFi connection is lost.
3. A Manual scan can be performed by selecting the "Scan" button. When the scan is complete the available cameras will be displayed.  
**Note:** Multiple cameras will be viewable during scanning/enrollment however, only four will appear on each page.
4. Select the desired camera from the list. If applicable select the "▽" button to view additional pages of the list. Select the "△" button to return to the previous page of the list.
5. The selected camera is highlighted in green. To edit the camera name go to step 6 OR to save the camera go to step 9.
6. To edit the camera name tap the highlighted camera again. After the highlight color changes to yellow, select the edit button.  
**Note:** To de-select a camera "tap" the highlighted camera two times.
7. Select the "Clear" button on displayed keypad, then enter the desired text.
8. Select "Done".
9. Select the "Back" button.
10. The system displays video from the selected camera.
11. To select a different camera, select the camera button then tap the selected camera two times and repeat steps 4 to 9 as applicable.
12. Refer to the Video Camera Controls table for information regarding the Video Function buttons. The available controls are dependent upon the cameras that have been installed and selected.

# USER FUNCTIONS

## Video Camera Control Feature

### Video Camera Reset

In the event that video streaming is lost, freezes or becomes pixelated the control can automatically or manually reset the video depending on the option that is selected. The system is defaulted to automatically recover within approximately 1 minute after communication has been restored.

### Reset Video Cameras

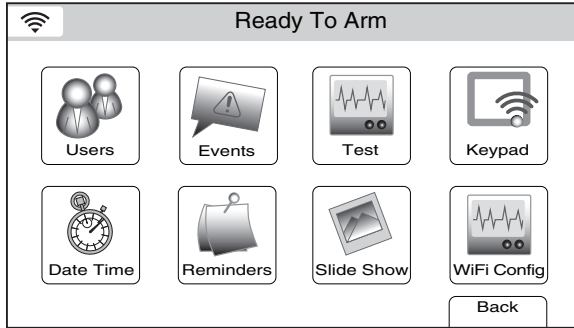

1. At the Master User screen select the WiFi Config icon. The system displays the WiFi options screen. The enabled recover mode will be displayed.

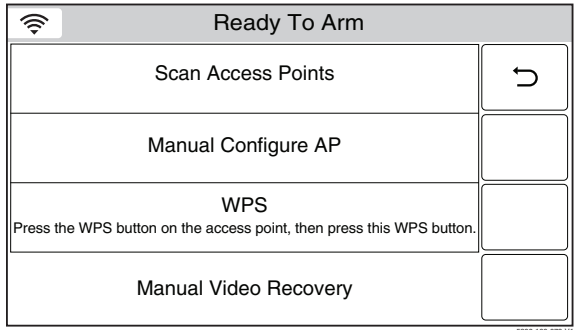

2. Selecting Automatic Video Recovery button will enable the manual feature or selecting the Manual Video Recovery button will enable the Automatic feature. The display toggles to display the selected mode and saves the entry.

- If Automatic Video Recovery is enabled with TotalConnect services, "Wait for Automatic Video Restore" will be displayed in a blue band. The video recovery will be automatically recovered within approximately 1 minute after the camera restores communication.
- If Automatic Video Recovery is enabled without TotalConnect services, the video recovery will begin automatically after the camera restores communication.
- If Automatic Video Recovery is enabled the video can be recovered manually.
- If Manual Video Recovery is enabled, "Double tap to restore video" will be displayed in a yellow band. The video recovery will begin automatically after the camera restores communication
- If the control is in the Armed Away state the camera must be recovered via the manual mode.

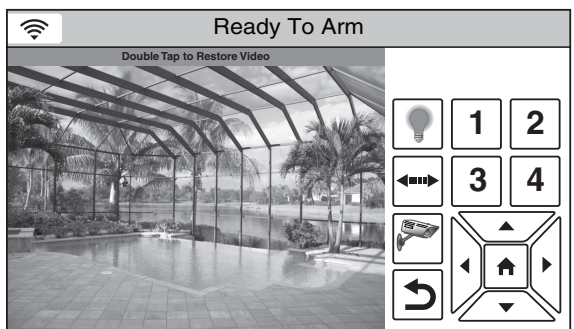

3. If Automatic Video Recovery is enabled, wait for the camera to automatically recover. If Manual Video Recovery is enabled, tap the video display two times to restore video.







**Note:** If the control is in the Armed Away state the camera must be recovered via the manual mode.

4. Upon recovery the video display will return to normal and the camera name will be displayed in a green band.

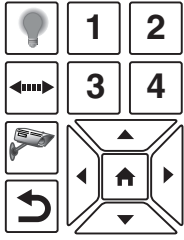
**Video Camera Control Feature**

**Video Camera Control**

The controls that are available are dependent upon the cameras that are installed with your system. Only those controls that are applicable to the specific camera will be displayed.

Button	Function
	<p><b>Video Camera Control</b>                      Button operation is dependent upon the features available in the camera that is installed/selected (i.e.; pan &amp; tilt and auxiliary LED light). Only the buttons that are applicable for the selected camera are displayed.</p> <p>Camera "Home" position - The camera's home position is centered in its vertical and horizontal axis.</p> <ul style="list-style-type: none"> <li>When a camera has been moved to <u>other than the home position</u>, if 5 minutes pass and no movement is detected, the camera will return to the home position.</li> </ul> <p><b>Notes</b></p> <ul style="list-style-type: none"> <li>Additional features can be programmed via TotalConnect 2.0. Check with your installer to see which features are available.</li> <li>In the event that video is lost, frozen or is pixelated and does not automatically reset, tap the display two times to manually restore the video.</li> </ul>
	<p><b>Preset buttons 1, 2, 3, 4</b> – These buttons are used to quickly drive a pan/tilt camera to a preset watch area. (Up to 4 preset watch areas can be set.) Select the button to go to the preset watch area. To set a preset watch area, use the arrow buttons to drive the camera to the desired area. Alternately, sweeping a finger across the screen, horizontally, vertically or diagonally will drive the camera in that direction. Then tap the desired 1, 2, 3, or 4 button three times. The selected button will be highlighted (for around 5 seconds) confirming that the preset is saved.</p> <p><b>Arrow buttons</b> – Used to position a PT (pan &amp; tilt) camera. Select to incrementally position a pan &amp; tilt camera (i.e; iPCAM-PT) in a vertical or horizontal direction.</p> <p><b>Center home button</b> – Click to drive the camera to its home position.</p>
	<p><b>Light</b> – Used to toggle on or off the camera's auxiliary lighting LEDs. Depending on the ambient low light conditions, the auxiliary lighting can improve video quality up to 15 feet.</p>
	<p><b>Auto pan</b> – Causes the camera to swing through its entire horizontal range. At the end of the panning motion, the camera will return to the starting position. After 5 minutes of no movement the camera will always return to the home position.</p>
	<p><b>Video Camera</b> – When selected, the panel displays a list of available video cameras.</p>
	<p><b>Return/Home</b> – Returns the control panel to the panel's Home Screen</p>

**Video Camera Indicators**

Displayed Text	Band	Meaning
"Name" OR Camera information	Green	Normal operation, selected camera
"Name" OR Camera information	Gray	Normal operation, unselected camera
"Wait for Automatic Video Restore..."	Blue	Displayed after communication has been restored. After a delay, Video restoration will begin automatically. The video can also be restored manually by tapping the display two times.
"Double Tap to Restore Video"	Yellow	Video restoration requires user to tap the display two times. Video will begin when communication is restored.
"Video No Longer Available"	Red	Communication with camera has been lost
Date & Time	Black	Displayed if programmed

# USER FUNCTIONS

## Speaker Phone Feature

If this feature has been programmed the LYNX Touch is capable of operating as a speaker phone. During speaker phone operation the system will provide the following functions:

- All function/event processing will continue to operate, but there will be no announcements.

**NOTE:** The system will enter the Speaker Phone mode even if an alarm or trouble is stored in the system memory.



**Do not use the speaker phone as the only telephone in your home since in some special cases the speaker phone is not functional.**

The system will not enter speaker phone mode and LYNX Touch will not ring if:

- The feature has not been programmed.
- A report is being sent.
- An audible alarm is present.
- An announcement is being made or a recorded message is being played back.
- A message is being recorded.
- If the system is in test mode.
- AC power is not present

The speaker phone will be aborted if:

- A report must be sent.
- An audible alarm or trouble has occurred.

### Using the Speaker Phone Feature

When the LYNX Touch is operating in the Speaker Phone mode, if a zone is violated and has triggered an entry/exit delay, the system will automatically change the touch screen from telephone to security mode. This allows the user to disarm the system or take other appropriate actions in the security mode without interrupting the telephone session. To regain telephone keypad control you will need to reactivate the telephone keypad.

### Placing a Call

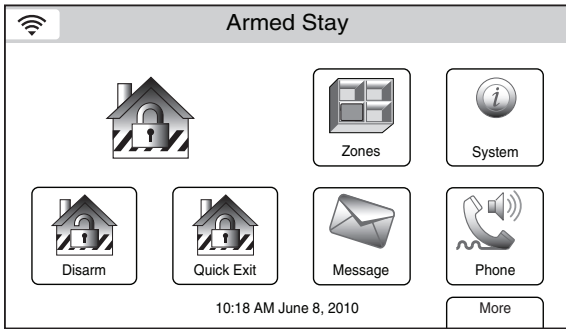

1. With the system in the disarmed or armed state, select the "Phone" icon from the Security Screen. The system displays the Keypad screen.

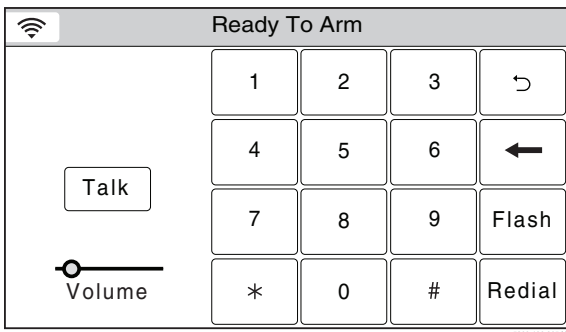

2. Select the "Talk" icon and then enter the number you wish to dial. The "End" icon replaces the "Talk" icon. Selecting the "Redial" icon will allow you to redial the last number that was dialed.
3. Select the "Flash" icon to switch between two calls.
4. Select the "End" icon to hang up and end the call.

# USER FUNCTIONS

## Speaker Phone Feature

### Answering a Call

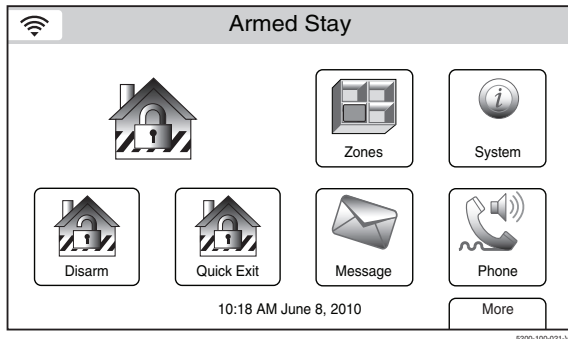

1. With the system in the disarmed or armed state, select the "Phone" icon from the Security Screen. The system displays the Keypad screen.

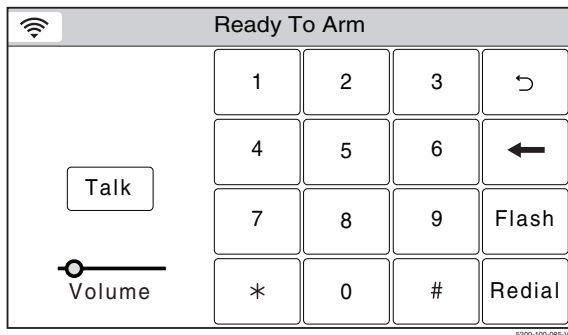

2. Select the "Talk" icon. The "End" icon replaces the "Talk" icon.
3. Select the "End" icon to hang up and end the call.

## **USER FUNCTIONS**

---

### **Remote Phone Control Feature**

The LYNX Touch Series is equipped with a remote interactive phone capability that permits access to the security system from any off-site touch-tone telephone using all user codes. The system will provide the appropriate voice messages and any system beeping sounds indicating the status of the security system over the phone line. Refer to *Summary of Audible Notification* section for further information.

The following functions can be performed from any remote touch-tone telephone:

- Disarm the system.
- Arm the system in STAY or AWAY mode.
- Bypass zones.
- Check system status.

The remote access session will be aborted if:

- A report must be sent.
- Any local or wireless key entry is made.
- User Code is not entered within eight (8) seconds of call pickup (during the “system.....system announcement).
- No keys are depressed for a period of 15 seconds and while no announcement has been made by the system. Any remote key entry will, however extend this timeout back to 15 seconds.

It will not be possible to begin a remote access session if:

- A report must be sent
- The system is in any Test mode.
- Panel is in shutdown mode (programmed by your installer).

### **Using Remote Phone Control Feature**

Dial the controls’s phone number. If no answering machine is present, the control will pick up between 1 and 14 rings, depending on the number programmed by your installer and will periodically announce “SYSTEM ENTER CODE”. If an answering machine is on the premises, you need to dial the premises and hang up on the first ring. Wait at least five (5) seconds (but no more than 22 seconds) and dial the premises phone number again. The control will pick up and periodically announce “SYSTEM”.

### **Remote Phone Control Commands**

Enter User Code (within eight seconds). Upon entering remote phone control mode the Lynx will announce “System, enter code”.

- To remotely disarm system: ..... User Code + [1]
- To remotely arm in AWAY mode: ..... User Code + [2]
- To remotely arm in STAY mode: ..... User Code + [3]
- To remotely arm in AWAY or STAY mode with no delay: ..... User Code + [2] or [3] + [0]
- To remotely Bypass zones: ..... User Code + [6] + zone no.
- To remotely activate Force Bypass: ..... User Code + [6] + [#]
- To remotely check system status: ..... [\*]
- To end remote phone session: Hang Up or ..... User Code + [9]

- Notes:** (1) Check with your installer to see if the Force Bypass mode has been enabled.  
(2) When bypassing zones, make sure a confirmation beep sounds for each zone that has been bypassed.

### **Two-Way Voice Feature (Alarm Audio Verification)**

This feature allows an operator at the Central Station to listen, talk to or conduct a two-way conversation with an individual(s) at your location. It also assists the operator in gathering information about the nature and location of the alarm that may be helpful in responding to police and/or fire departments. All LYNX Touch control panels are capable of supporting the Two-Way Voice feature. The LYNX Touch does not make system announcements when the Two-Way voice feature is active.

If a WiFi connection is being used for Two-Way Voice (AAV), sufficient bandwidth must be available.

- AAV requires a continuous WiFi upload/download bandwidth of 90kbps for proper operation.
- WiFi bandwidth less than 90kbps may result in degraded performance.



---

**Fire and CO alarms will prevent the LYNX Touch from starting an Two-Way Voice session. A new Fire or CO alarm will end a Two-Way Voice session that is in progress.**

---

If the Two-way Voice Feature has been programmed and an alarm condition is detected, the system sends an alarm message to the central station. After acknowledgement is received, a “listen in to follow” message is sent to the central station. In response to this message, the central station operator can enter commands that allow initiation of a 5-minute voice session.

When activated, the Two-Way Voice (AAV) feature enters the “Listen Mode” and sirens and keypad sounds are discontinued. The Central Station operator begins the session, which lasts 5 minutes, and may be extended 5 minutes, without changing the operating mode. If a subsequent security zone is violated during a voice session, the session will continue and the alarm will be buffered. If a fire zone is violated during a voice session, the system will terminate the session and process the alarm. The Two-Way Voice modes are described as follows:

**Talk Mode:** Enables one-way voice communication from the central station to the violated premises, and allows the operator to communicate through the built-in speaker on the LYNX Touch. In this mode the “Panic” function key is lit Red and the “Home” function key is alternately lit Red and Green.

**VOX (Voice) Mode:** Enables two-way voice communications between the Central Station and the violated premises via the built-in speaker and microphone on the LYNX Touch. In this mode, the “Panic” function key is lit Red and the “Home” function key is alternately lit Red and Green.

**Listen Mode:** Enables one-way audio from the violated premises to the central station. The Listen Mode is the start up default mode of the voice feature and allows the operator to listen through the LYNX Touch microphone. During the voice session the “Panic” function key is lit Red and the “Home” function key is alternately blinks Green and off.

## ***USER FUNCTIONS***

---

### ***Remote Services***

Your security system may be capable of providing a series of web-based services that allow you to communicate with your security system remotely in a number of ways. These features are enabled through Total Connect Service and provide the ability to:

- Access to your security system from a computer via website (Remote Access Feature)
- Receive e-mail and text message notification of system events (Multi-Mode Feature)
- Perform system functions and receive confirmations using text messages (SMS Feature)
- Program/operate home automation devices.

Ask your installer if your system employs a remote services capable device.



The LYNX Touch features a Slide Show/Screen Saver feature. The feature allows images to be displayed on the touch screen when it is not in use. Connection to Total Connect Service is required in order for your installer to upload images to your panel. For more information about this option, speak to your installer.

### Activating the Slide Show

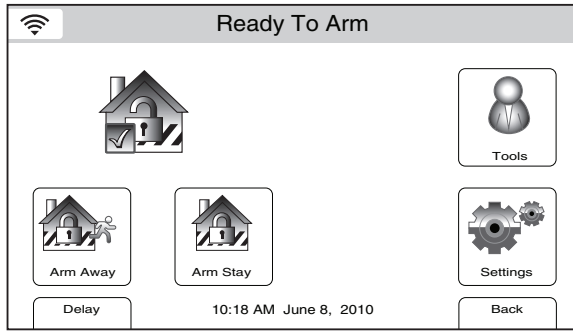

1. With the system in the disarmed state, select the “Tools” icon from the second page of the Security Screen. The system displays the Keypad screen.

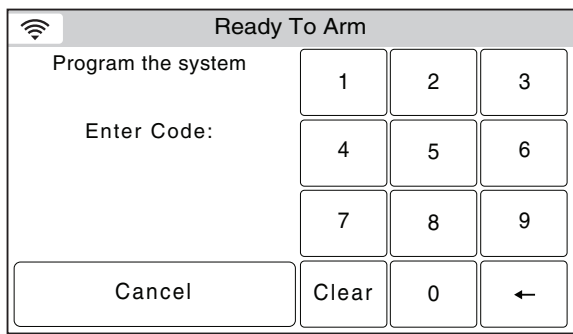

2. Enter your 4-digit Master User Code. The system displays the Master User programming screen.

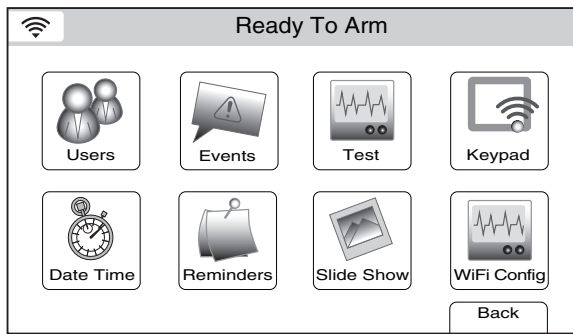

3. Select the “Slide Show” icon. The system displays the first Slide Show screen.

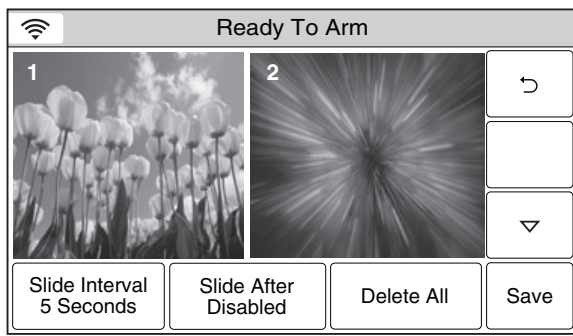

4. Select the “Slide Show” icons that you do not wish to display or select “Delete All”. Use the “▲” “▼” buttons to scroll to second and subsequent pages of screens.
5. Select the “Slide Interval” button. The system scrolls through the following options:
  - Slide Interval 5 Seconds
  - Slide Interval 10 Seconds
  - Slide Interval 15 Seconds
  - Slide Interval 20 Seconds
6. Select the “Slide After Disabled” button. The system scrolls through the following options:
  - Slide After Disabled (disables the Slide Show)
  - Slide After 30 Seconds
  - Slide After 2 Minutes
  - Slide After 10 Minutes
  - Slide After 30 Minutes
7. Once selections are complete, select the “Save” button.

## SUMMARY OF AUDIBLE & VISUAL NOTIFICATIONS

### Audible Soundings

SOUND	CAUSE	ANNOUNCEMENT*
INTERRUPTED	FIRE ALARM (3 beeps) OR CARBON MONOXIDE ALARM (4 beeps)	fire alarm + zone voice descriptor OR Carbon monoxide alarm + zone voice descriptor (Voice descriptor is interlaced with the sounder and sounds every 45 seconds)
CONTINUOUS	BURGLARY/AUDIBLE EMERGENCY ALARM	alarm + zone voice descriptor (Voice descriptor is interlaced with the sounder and sounds every 45 seconds)
ONE SHORT BEEP (not repeated)	a. SYSTEM DISARM b. SYSTEM ARMING ATTEMPT WITH AN OPEN ZONE. c. BYPASS VERIFY	a. disarmed–ready to arm b. disarmed–not ready to arm c. zones bypassed
ONE SHORT BEEP (once every 45 secs)	a. SYSTEM IS IN TEST MODE b. LOW BATTERY AT A TRANSMITTER c. SYSTEM LOW BATTERY d. FAIL TO COMMUNICATE	a. no announcement b. low battery + zone voice descriptor c. system low battery d. check system
TWO SHORT BEEPS	ARM AWAY	armed away [instant] – exit now
THREE SHORT BEEPS	a. ARM STAY OR INSTANT b. ZONE OPENED WHILE SYSTEM IS IN CHIME MODE.	a. armed stay [instant] – exit now b. zone voice descriptor
RAPID BEEPING	a. TROUBLE b. MEMORY OF ALARM	a. fault + zone voice descriptor b. fire alarm or alarm + zone voice descriptor
SLOW BEEPING	a. ENTRY DELAY WARNING b. EXIT DELAY WARNING	a. disarm system now b. armed [away] [instant] – exit now

#### Additional Announcements:

The system will announce the following primary messages, depending on the system's status at the time:

- Disarmed–Ready to Arm [check system][chime]
- Disarmed [not ready to arm][chime]
- Armed [away] [stay] [instant] [check system] [exit now]

# SUMMARY OF AUDIBLE & VISUAL NOTIFICATIONS

## System Displays

The following icons will be displayed on the Security Screen along with specific zone status information (if applicable) to indicate system status.

DISPLAY	DEFINITION
	AC Loss
	Alarm (intrusion)
	Armed Away
	Armed Stay
	Battery Low
	Check Zones
	CO Alarm
	Disarmed Not Ready to Arm
	Disarmed Ready to Arm
	Door Open

DISPLAY	DEFINITION
	Window Open
	Exit Active
	Fire OR Heat Sensor
	Flood
	Glass Break
	Medical Alarm
	Motion
	Temperature
	Reporter Failure

DISPLAY	DEFINITION
	Cover Tamper
	Trouble
	90 RF Jam
	Automation (Z-Wave Node Failed)
	WiFi source present
	No WiFi source
	Fault * Garage Door
	94 Phone Line Cut
	103 Comm. Trouble

### Zone Status Icons

The following icons may be displayed on the Zone Status screen.

ICON	DEFINITION
	Alarm
	Fault (Yellow)

ICON	DEFINITION
	Trouble (red)
	Bypass

ICON	DEFINITION
	Ready

### LED Status

Armed LED (Red): ON = System armed  
 OFF = System disarmed  
 Blinking = System armed, but a fault exists or alternating with Ready LED when Two Way Voice (VOX or Talk), speaker phone or programming mode is active.

Ready LED (Green): ON = System disarmed, ready to arm  
 Blinking = System disarmed, not ready to arm (a fault exists) or alternating with Armed LED when Two Way Voice (VOX or Talk), speaker phone or programming mode is active.

**Note:** When the system is armed, the Ready LED turns off.

# SYSTEM FUNCTIONS

## Testing the System (to be conducted weekly)

### Test Modes

The Test icon provides access to the Walk Test, Dialer Test, Communications Test and Reboot functions. The Walk Test mode allows each protection point to be checked for proper operation. When the Walk Test mode is active, the control sounds a single beep every 30 seconds as a reminder that the system is in the Test mode. The Dialer Test performs a check of the system dialer. The Communications Test performs a check of the WiFi and/or GSM communications. The Reboot feature allows you to reboot the system if required.

**NOTE:** An alarm message will not be sent to your alarm monitoring company during these tests.

### Entering Test Mode

Disarm the system and close all protected windows, doors, etc. The “Ready” indicator should be lit.

### Testing or Rebooting the System

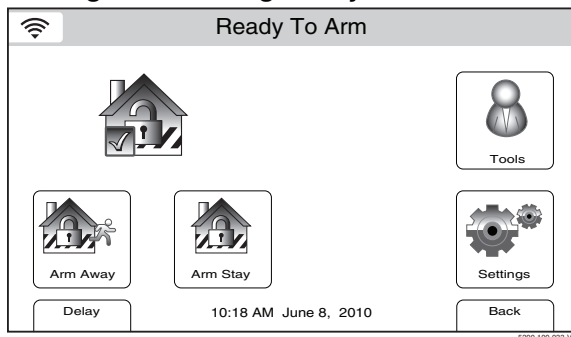

1. With the system in the disarmed state, select the “Tools” icon from the second page of the Security Screen. The system displays the Keypad screen.

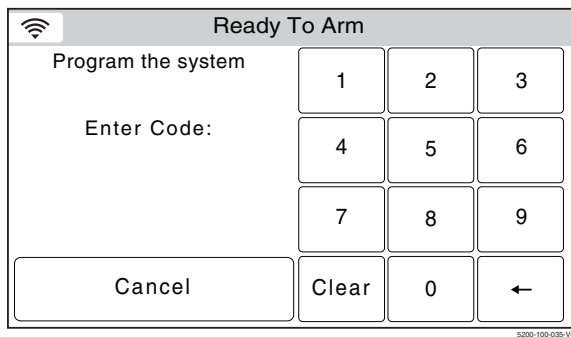

2. Enter your 4-digit Master User Code. The system displays the Keypad screen.

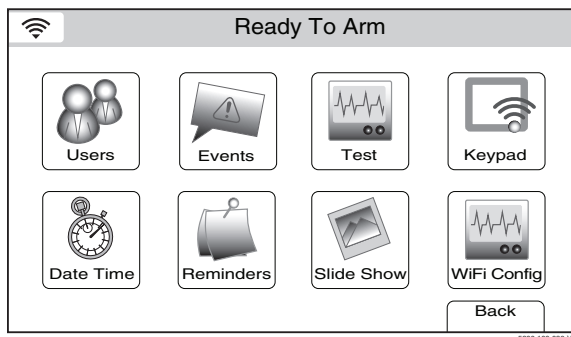

3. Select the “Test” icon. The system displays the Test screen.

## Testing the System (to be conducted weekly)

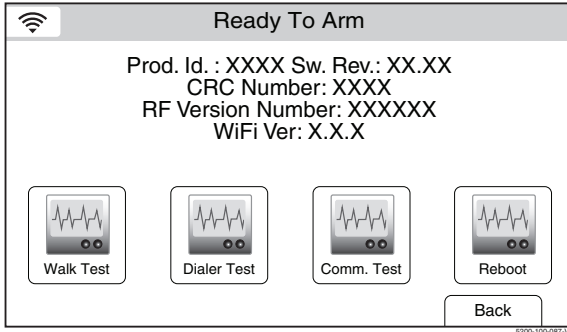

4. Select the “Walk Test”, “Dialer Test”, “Comm. Test” or “Reboot” icon. If Walk Test is selected proceed to Step 5. If Dialer Test is selected proceed to Step 6. If Comm. Test is selected proceed to Step 7. If Reboot is selected proceed to Step 8.
5. “Walk Test...” is displayed on the system status bar and the control sounds a single beep every 30 seconds. Fault each zone as described below.
6. If the dialer test is unsuccessful after 8 attempts, the system will display a Reporter Failure message. Contact your security service provider.
7. The system will advance to the Communications Test Screen. Refer to the Communications Test paragraph.
8. The system will reboot itself.
9. After the reboot sequence is completed, conduct a Walk Test to verify that all transmitters are operational in the system.

### Walk Test

**FAULT ZONES.** Open each protected door and window in turn and listen for three beeps from the control, followed by the zone’s Voice Descriptor, if it is programmed. Identification of each faulted protection point should appear on the display. The display will clear when the door or window is closed.

Walk in front of any interior motion detectors (if used) and listen for three beeps and/or voice descriptors, if programmed. The identification of the detector should appear on the display when it is activated, and its voice descriptor will be announced (if programmed). The display will clear when no motion is detected. Note that if wireless motion detectors are used, in order to conserve battery life, there is a 3-minute delay between activations.

To test all smoke detectors, follow the manufacturer's instructions. The identification of each detector should appear on the display when each is activated.

If a problem is experienced with any protection point (no confirming sounds, no display), notify your service company.

When all protection points have been checked and are intact (closed), there should be no zone identification numbers displayed on the touch screen.

### Test Communications

Depending upon the Communication device that installed in your system the following options may be displayed. Select the desired option to send a test alarm to the Central Station.

- Test Ethernet

If the test is successful, the System displays: **Service OK**

- Send Any
- Send GSM Message
- Send Ethernet Message

If the test is successful, the System displays: **Test Message Sent**

If the test is not successful, the System displays: **Test Message Failed – Not Registered!**

### Exiting Test Mode

When testing is completed, exit the Walk Test or Comm. Test mode by selecting the Home key and entering the Master User Code (if required).

**NOTE:** If the Walk Test mode is inadvertently left active, it automatically turns off after 4 hours.

#### LYNX Touch

The LYNX Touch will send an event code to the Central Station after entering and after exiting from Test mode.

# SYSTEM FUNCTIONS

## Maintaining your system

The components of your security system are designed to be as maintenance-free as possible. To make sure that your system is in working condition, do the following:

1. Test your system weekly (see the *Testing the System* section).
2. Test your system after any alarm occurs (see the *Testing the System* section).
3. Clean the touch screen weekly.

### Routine Care

- Treat the components of your security system as you would any other electrical equipment. Do not slam sensor-protected doors or windows.
- Keep dust from accumulating on the touch screen and all protective sensors, particularly on motion sensors and smoke detectors.
- The touch screen and sensors should be cleaned carefully with a dry soft cloth. **Do not spray water or any other fluid on the units.**

### Cleaning the Touch screen

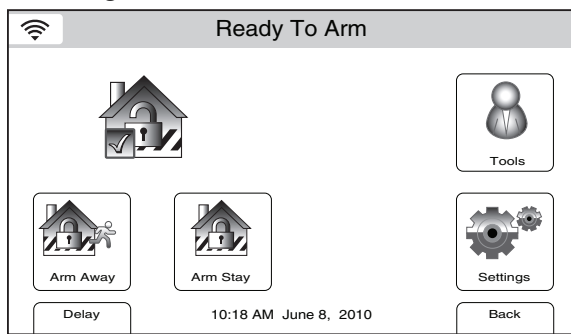

1. With the system in the disarmed or armed state, select the "Settings" icon from the second page of the Security Screen. The system displays the Settings" screen.

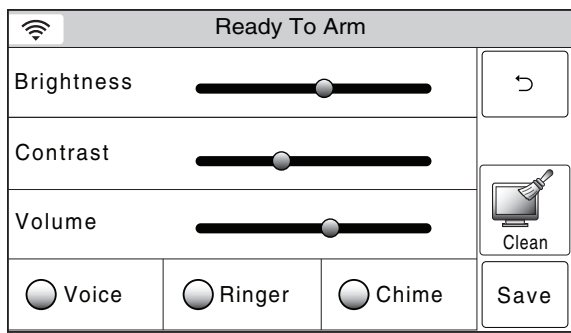

2. Select the "Clean" icon. The touch screen becomes inactive for a period of 15 seconds. A box displays "Please Use A Damp, Soft Cloth Touch Screen Will Be Disabled For 15 Seconds" and the time will count down.
3. After 15 seconds the screen returns to the settings screen and becomes active.

**Note:** If any user notification events occur while the screen cleaning mode is active and the system is armed, the mode will be canceled and the system will operate normally. If certain user notification events occur (i.e.; motion or silent alarm) while the screen cleaning mode is active and the system is disarmed the mode will not be canceled.

### Low Battery Conditions in Wireless Sensors

Each wireless sensor in your system has an internal battery. The system detects low battery conditions in wireless sensors, including smoke detectors, personal emergency transmitter, and the portable wireless keypad, and displays a "Battery Low" message on the touch screen, which also beeps. A low battery in a wireless keypad is detected as soon as one of its keys is pressed. In addition, a wireless smoke detector with a low battery also emits a "chirp" sound approximately once every 20–30 seconds, identifying itself as the smoke detector with the weak battery.

**NOTE:** A low battery message means that battery replacement in the indicated sensor(s) is due within 30 days. In the meantime, a sensor with a low battery is still operational.

To silence Low Battery Warning Tones, enter a valid code. The low battery message display will remain on as a reminder. When you replace the weak battery with a fresh one, the sensor will send a "good battery" signal to the control when the sensor is activated (opening/closing of door, window, etc.). To clear the "Low Battery" message, enter a valid code.

## **SYSTEM FUNCTIONS**

### ***Maintaining your system***

**When replacing batteries, use only those recommended by your installer.**

Alkaline batteries provide a minimum of 1 year of operation, and in most units and applications, provide 2–4 years of service. 3-volt lithium batteries may provide from 4-7 years of operation. Actual battery life will depend on the environment in which the sensor is used, the number of signals that the transmitter in the sensor has had to send, and the specific type of sensor. Factors such as humidity, high or low temperatures, and large swings in temperature may all lead to the reduction of actual battery life in an installation.

#### **Changing the LYNX Touch Series System Battery**

In the event of an AC power loss, the LYNX Touch Series is powered by a rechargeable, nickel-metal hydride battery pack. The battery pack should be replaced when a “Battery Low” message with no zone number is displayed.

**NOTE:** The battery pack (P/N LYNXRCHKIT-SC or LYNXRCHKIT-SHA) should be changed every four years and must be replaced by a qualified service technician.

Following battery pack replacement, rechargeable batteries may take up to 48 hours to charge. The “Battery Low” message may be displayed after one minute, however it should clear within 4 hours or by entering Test Mode.

## **FIRE/CO ALARM SYSTEM (If Installed)**

---

### **General Information**



LYNX Touch is not intended for UL985 Household Fire applications unless a 24-hour backup battery (P/N LYNXRCHKIT-SHA) is installed.

---

#### **General**

Your fire alarm system (if installed) is active 24 hours a day, providing continuous protection. In the event of an emergency, the installed smoke, heat and/or carbon monoxide detectors will automatically activate your security system, triggering a loud, intermittent sound from the touch screen. The sound will be interlaced with the voice descriptor, sounding every 15 seconds. A “FIRE” or “CO” message will appear at your touch screen and remain on until you silence and clear the alarm display.

#### **In Case of Fire**

1. Should you become aware of a fire emergency *before* your detectors sense the problem, go to the LYNX Touch and press and hold the panic button and then select the Fire icon. The alarm will sound and an alarm will be transmitted to the central station.
2. Evacuate all occupants from the premises.
3. If flames and/or smoke are present, leave the premises and notify your local Fire Department immediately.
4. If no flames or smoke are apparent, investigate the cause of the alarm. The zone number of the zone(s) in an alarm condition will appear at the touch screen.

#### **In Case of Carbon Monoxide Alarm**

1. If a high level of carbon monoxide is detected you should evacuate all occupants from the premises and immediately move to a spot where fresh air is available, preferably outdoors.
2. From a safe area, contact your security service provider for further instructions.

#### **Silencing a Fire/Carbon Monoxide Alarm**

1. Silence the alarm by entering a valid code.
2. To clear the alarm, select the “Home” key and entering a valid code again.
3. If the touch screen still indicates a trouble condition, check that smoke detectors are not responding to smoke- or heat-producing objects in their vicinity. Should this be the case, eliminate the source of heat or smoke.
4. If this does not remedy the problem, there may still be smoke in the detector. Clear it by fanning the detector for about 30 seconds.
5. When the problem has been corrected, clear the display by selecting the “Home” key and entering a valid code again.



# FIRE/CO ALARM SYSTEM

## National Fire Protection Association Smoke Detector Recommendations

**UL** LYNX Touch is not intended for UL985 Household Fire applications unless a 24-hour backup battery (P/N LYNXRCHKIT-SHA) is installed.

With regard to the number and placement of smoke and heat detectors, we subscribe to the recommendations contained in the National Fire Protection Association's (NFPA) Standard #72 noted below.

Early warning fire detection is best achieved by the installation of fire detection equipment in all rooms and areas of the household. The equipment should be installed as follows: A smoke detector installed outside of each separate sleeping area, in the immediate vicinity of the bedrooms and on each additional story of the family living unit, including basements and excluding crawl spaces and unfinished attics.

In addition, the NFPA recommends that you install heat or smoke detectors in the living room, dining room, bedroom(s), kitchen, hallway(s), attic, furnace room, utility and storage rooms, basements and attached garages.

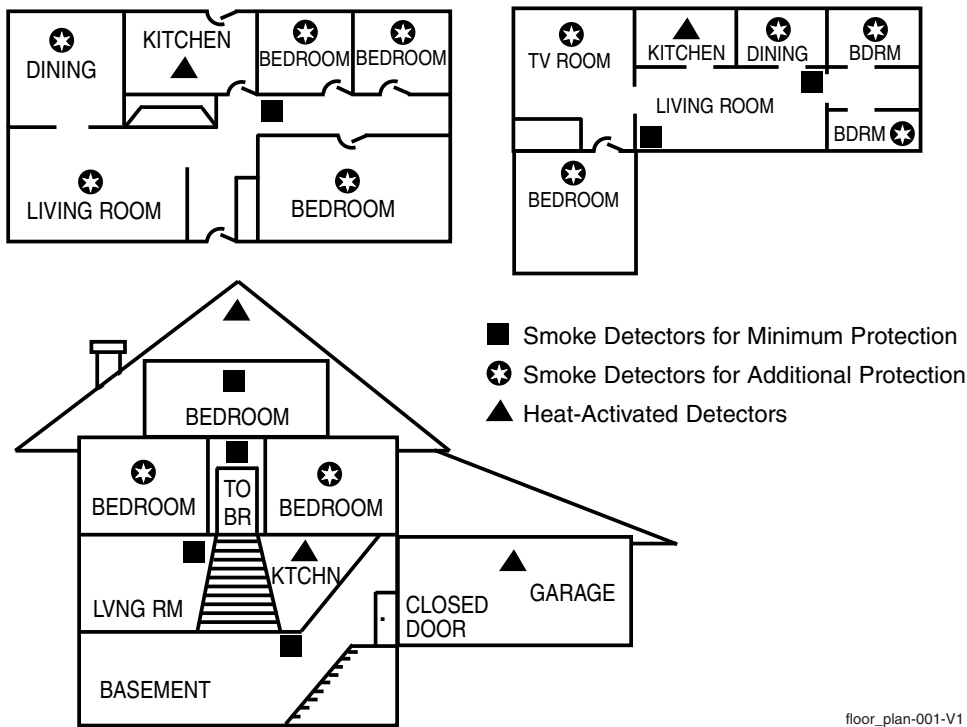

floor\_plan-001-V1

# FIRE/CO ALARM SYSTEM

## Emergency Evacuation

**UL**

LYNX Touch is not intended for UL985 Household Fire applications unless a 24-hour backup battery (P/N LYNXRCHKIT-SHA) is installed.

Establish and regularly practice a plan of escape in the event of fire. The following steps are recommended by the National Fire Protection Association:

1. Position your detector or your interior and/or exterior sounders so that they can be heard by all occupants.
2. Determine two means of escape from each room. One path of escape should lead to the door that permits normal exit from the building. The other should be an alternative escape, such as a window, should your path to that door be unpassable. Station an escape ladder at such windows if there is a long drop to the ground.
3. Sketch a floor plan of the building. Show windows, doors, stairs and rooftops that can be used to escape. Indicate escape routes for each room. Keep these routes free from obstruction and post copies of the escape routes in every room.
4. Assure that all bedroom doors are shut while you are asleep. This will prevent deadly smoke from entering while you escape.
5. Try the door. If the door is hot, check your alternate escape route. If the door is cool, open it cautiously. Be prepared to slam the door if smoke or heat rushes in.
6. When smoke is present, crawl on the ground. Do not walk upright, since smoke rises and may overcome you. Clearer air is near the floor.
7. Escape quickly; don't panic.
8. Establish a place outdoors, away from your house, where everyone can meet and then take steps to contact the authorities and account for those missing. Choose someone to assure that nobody returns to the house — many die going back.

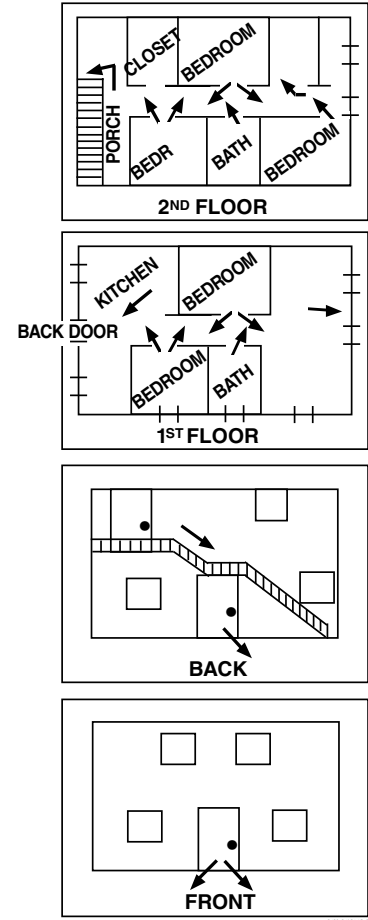

## Federal Communications Commission (FCC) Part 15

The user shall not make any changes or modifications to the equipment unless authorized by the Installation Instructions or User's Manual. Unauthorized changes or modifications could void the user's authority to operate the equipment.

### CLASS B DIGITAL DEVICE STATEMENT

NOTE: This equipment has been tested and found to comply with the limits for a Class B digital device, pursuant to part 15 of the FCC Rules. These limits are designed to provide reasonable protection against harmful interference in a residential installation. This equipment generates, uses and can radiate radio frequency energy and, if not installed and used in accordance with the instructions, may cause harmful interference to radio communications. However, there is no guarantee that interference will not occur in a particular installation. If this equipment does cause harmful interference to radio or television reception, which can be determined by turning the equipment off and on, the user is encouraged to try to correct the interference by one or more of the following measures:

- Reorient or relocate the receiving antenna.
- Increase the separation between the equipment and receiver.
- Connect the equipment into an outlet on a circuit different from that to which the receiver is connected.
- Consult the dealer or an experienced radio/TV technician for help.

This Class B digital apparatus complies with Canadian ICES-003.

Cet appareil numérique de la classe B est conforme à la norme NMB-003 du Canada.

### Industry Canada (IC)

This device complies with Part 15 of FCC Rules and RSS210 of Industry Canada. Operation is subject to the following two conditions: (1) This device may not cause harmful interference, and (2) This device must accept any interference received, including interference that may cause undesired operation.

Cet appareil est conforme à la partie 15 des règles de la FCC & de RSS 210 des Industries Canada. Son fonctionnement est soumis aux conditions suivantes: (1) Cet appareil ne doit pas causer d'interférences nuisibles. (2) Cet appareil doit accepter toute interférence reçue y compris les interférences causant une réception indésirable.

## TELEPHONE/MODEM INTERFACE

### Federal Communications Commission (FCC) Part 68

This equipment complies with Part 68 of the FCC rules. On the cover of this equipment is a label that contains the FCC registration number and Ringer Equivalence Number (REN). You must provide this information to the telephone company when requested.

This equipment uses the following USOC jack: RJ31X

This equipment may not be used on telephone-company-provided coin service. Connection to party lines is subject to state tariffs. This equipment is hearing-aid compatible.

### Industry Canada

**NOTICE:** The Industry Canada Label identifies certified equipment. This certification means that the equipment meets telecommunications network protective, operational and safety requirements as prescribed in the appropriate Terminal Equipment Technical Requirements document(s). The Department does not guarantee the equipment will operate to the user's satisfaction.

Before installing this equipment, users should ensure that it is permissible to be connected to the facilities of the local telecommunications company. The equipment must also be installed using an acceptable method of connection. The customer should be aware that compliance with the above conditions may not prevent degradation of service in some situations.

Repairs to certified equipment should be coordinated by a representative designated by the supplier. Any repairs or alterations made by the user to this equipment, or equipment malfunctions, may give the telecommunications company to request the user to disconnect the equipment.

Users should ensure for their own protection that the electrical ground connections of the power utility, telephone lines and internal metallic water pipe system, if present, are connected together. This precaution may be particularly important in rural areas.

**Caution:** Users should not attempt to make such connections themselves but should contact appropriate electric inspection authority, or electrician, as appropriate.

**AVIS:** L'étiquette d'Industrie Canada identifie le matériel homologué. Cette étiquette certifie que le matériel est conforme aux normes de protection, d'exploitation et de sécurité des réseaux de télécommunications, comme le prescrivent les documents concernant les exigences techniques relatives au matériel terminal. Le Ministère n'assure toutefois pas que le matériel fonctionnera à la satisfaction de l'utilisateur.

Avant d'installer ce matériel, l'utilisateur doit s'assurer qu'il est permis de le raccorder aux installations de l'entreprise locale de télécommunication. Le matériel doit également être installé en suivant une méthode acceptée de raccordement. L'abonné ne doit pas oublier qu'il est possible que la conformité aux conditions énoncées ci-dessus n'empêche pas la dégradation du service dans certaines situations.

Les réparations de matériel homologué doivent être coordonnées par un représentant désigné par le fournisseur. L'entreprise de télécommunications peut demander à l'utilisateur de débrancher un appareil à la suite de réparations ou de modifications effectuées par l'utilisateur ou à cause de mauvais fonctionnement.

Pour sa propre protection, l'utilisateur doit s'assurer que tous les fils de mise à la terre de la source d'énergie électrique, de lignes téléphoniques et des canalisations d'eau métalliques, s'il y en a, sont raccordés ensemble. Cette précaution est particulièrement importante dans les régions rurales.

**Avertissement :** L'utilisateur ne doit pas tenter de faire ces raccordements lui-même; il doit avoir recours à un service d'inspection des installations électriques, ou à un électricien, selon le cas.

### Ringer Equivalence Number Notice:

The Ringer Equivalence Number (REN) assigned to each terminal device provides an indication of the maximum number of terminals allowed to be connected to a telephone interface. The termination on an interface may consist of any combination of devices subject only to the requirement that the sum of the Ringer Equivalence Numbers of all the devices does not exceed 5.

**AVIS :** L'indice d'équivalence de la sonnerie (IES) assigné à chaque dispositif terminal indique le nombre maximal de terminaux qui peuvent être raccordés à une interface. La terminaison d'une interface téléphonique peut consister en une combinaison de quelques dispositifs, à la seule condition que la somme d'indices d'équivalence de la sonnerie de tous les dispositifs n'excède pas 5.



### RF Exposure Warning

The antenna(s) used for this transmitter must be installed to provide a separation distance of at least 7.8 in (20 cm) from all persons and must not be co-located or operating in conjunction with any other transmitter except in accordance with FCC multi-transmitter product procedures.

## SERVICING INFORMATION

Your local Honeywell dealer is the person best qualified to service your alarm system. Arranging some kind of regular service program with him is advisable.

Your local Honeywell dealer is:

Name: \_\_\_\_\_

Address: \_\_\_\_\_

\_\_\_\_\_

Phone: \_\_\_\_\_

## OWNER'S INSURANCE PREMIUM CREDIT REQUEST

This form should be completed and forwarded to your homeowner's insurance carrier for possible premium credit.

### A. GENERAL INFORMATION:

Insured's Name and Address: \_\_\_\_\_  
\_\_\_\_\_

Insurance Company: \_\_\_\_\_ Policy No.: \_\_\_\_\_

**LYNX Touch Series** \_\_\_\_\_ **Other**

Type of Alarm:  Burglary  Fire  Both

Installed by: \_\_\_\_\_ Serviced by: \_\_\_\_\_  
Name Name

\_\_\_\_\_ Address Address

### B. NOTIFIES (Insert B = Burglary, F = Fire)

Local Sounding Device \_\_\_\_\_ Police Dept. \_\_\_\_\_ Fire Dept. \_\_\_\_\_

Central Station  Name: \_\_\_\_\_

Address: \_\_\_\_\_

Phone: \_\_\_\_\_

### C. POWERED BY: A.C. With Rechargeable Power Supply

**D. TESTING:**  Quarterly  Monthly  Weekly  Other \_\_\_\_\_

(continued on other side)

**OWNER'S INSURANCE PREMIUM CREDIT REQUEST (cont.)**

**E. SMOKE DETECTOR LOCATIONS**

- Furnace Room                       Kitchen                       Bedrooms                       Attic  
 Basement                       Living Room                       Dining Room                       Hall

**F. BURGLARY DETECTING DEVICE LOCATIONS:**

- Front Door                       Basement Door                       Rear Door                       All Exterior Doors  
 1st Floor Windows                       All Windows                       Interior Locations  
 All Accessible Openings, Including Skylights, Air Conditioners and Vents

**G. ADDITIONAL PERTINENT INFORMATION:**

---

---

---

---

---

Signature: \_\_\_\_\_ Date: \_\_\_\_\_

## WARNING!

### THE LIMITATIONS OF THIS ALARM SYSTEM

While this system is an advanced design security system, it does not offer guaranteed protection against burglary or fire or other emergency. Any alarm system, whether commercial or residential, is subject to compromise or failure to warn for a variety of reasons. For example:

- Intruders may gain access through unprotected openings or have the technical sophistication to bypass an alarm sensor or disconnect an alarm warning device.
- Intrusion detectors (e.g. passive infrared detectors), smoke detectors, and many other sensing devices will not work without power. Battery operated devices will not work without batteries, with dead batteries, or if the batteries are not put in properly. Devices powered solely by AC will not work if their AC power supply is cut off for any reason, however briefly.
- Signals sent by wireless transmitters may be blocked or reflected by metal before they reach the alarm receiver. Even if the signal path has been recently checked during a weekly test, blockage can occur if a metal object is moved into the path.
- A user may not be able to reach a panic or emergency button quickly enough.
- While smoke detectors have played a key role in reducing residential fire deaths in the United States, they may not activate or provide early warning for a variety of reasons in as many as 35% of all fires, according to data published by the Federal Emergency Management Agency. Some of the reasons smoke detectors used in conjunction with this System may not work are as follows. Smoke detectors may have been improperly installed and positioned. Smoke detectors may not sense fires that start where smoke cannot reach the detectors, such as in chimneys, in walls, or roofs, or on the other side of closed doors. Smoke detectors also may not sense a fire on another level of a residence or building. A second floor detector, for example, may not sense a first floor or basement fire. Moreover, smoke detectors have sensing limitations. No smoke detector can sense every kind of fire every time. In general, detectors may not always warn about fires caused by carelessness and safety hazards like smoking in bed, violent explosions, escaping gas, improper storage of flammable materials, overloaded electrical circuits, children playing with matches, or arson. Depending upon the nature of the fire and/or the locations of the smoke detectors, the detector, even if it operates as anticipated, may not provide sufficient warning to allow all occupants to escape in time to prevent injury or death.
- Passive Infrared Motion Detectors can only detect intrusion within the designed ranges as diagrammed in their installation manual. Passive Infrared Detectors do not provide volumetric area protection. They do create multiple beams of protection, and intrusion can only be detected in unobstructed areas covered by those beams. They cannot detect motion or intrusion that takes place behind walls, ceilings, floors, closed doors, glass partitions, glass doors, or windows. Mechanical tampering, masking, painting or spraying of any material on the mirrors, windows or any part of the optical system can reduce their detection ability. Passive Infrared Detectors sense changes in temperature; however, as the ambient temperature of protected area approaches the temperature range of 90° to 105°F, the detection performance can decrease.
- Alarm warning devices such as sirens, bells or horns may not alert people or wake up sleepers if they are located on the other side of closed or partly open doors. If warning devices sound on a different level of the residence from the bedrooms, then they are less likely to waken or alert people inside the bedrooms. Even persons who are awake may not hear the warning if the alarm is muffled from a stereo, radio, air conditioner or other appliance, or by passing traffic. Finally, alarm warning devices, however loud, may not warn hearing-impaired people or waken deep sleepers.
- Telephone lines needed to transmit alarm signals from a premises to a central monitoring station may be out of service or temporarily out of service. Telephone lines are also subject to compromise by sophisticated intruders.
- Even if the system responds to the emergency as intended, however, occupants may have insufficient time to protect themselves from the emergency situation. In the case of a monitored alarm system, authorities may not respond appropriately.
- This equipment, like other electrical devices, is subject to component failure. Even though this equipment is designed to last as long as 10 years, the electronic components could fail at any time.

The most common cause of an alarm system not functioning when an intrusion or fire occurs is inadequate maintenance. This alarm system should be tested weekly to make sure all sensors and transmitters are working properly.

Installing an alarm system may make one eligible for lower insurance rates, but an alarm system is not a substitute for insurance. Homeowners, property owners and renters should continue to act prudently in protecting themselves and continue to insure their lives and property.

We continue to develop new and improved protection devices. Users of alarm systems owe it to themselves and their loved ones to learn about these developments.

## **IN THE EVENT OF TELEPHONE OPERATIONAL PROBLEMS**

In the event of telephone operational problems, disconnect the control by removing the plug from the RJ31X (CA38A in Canada) telephone wall jack. We recommend that your certified installer demonstrate disconnecting the phones on installation of the system. Do not disconnect the phone connection inside the control/communicator. Doing so will result in the loss of your phone lines. If the regular phone works correctly after the control/communicator has been disconnected from the phone lines, the control/communicator has a problem and should be returned for repair. If upon disconnection of the control/communicator, there is still a problem on the line, notify the telephone company that they have a problem and request prompt repair service. The user may not under any circumstances (in or out of warranty) attempt any service or repairs to the system. It must be returned to the factory or an authorized service agency for all repairs.



**- NOTES-**

**- NOTES-**

**- NOTES-**

**- NOTES-**

# - INDEX -

5-Day Forecast .....13

## A

Alarm cancelled.....7, 24  
Alarm exit error .....24  
Alarm reporting delay .....7  
Alarms .....6  
Arm night .....19  
Armed indicator .....23  
Armed LED indicator .....10  
Arrow buttons .....59  
Audible emergency/audible alarm .....30  
Auto pan .....59  
Auto stay arming feature .....18  
Auto stay feature .....7  
Automation .....13, 44  
Auxiliary keypads .....56  
Away mode ..... 6, 8, 20, 23, 24

## B

Battery ..... 12, 66, 69, 69, 70, 72, 72, 73  
Battery conditions .....70  
Battery low .....70  
Battery pack .....70  
Burglary protection.....5, 6  
Bypass a zone .....8  
Bypassing protection zones ..... 6, 28, 29, 33

## C

Camera .....57  
Central monitoring station.....6, 79  
Checking system status .....8  
Chime mode ..... 6, 8, 10, 31  
Cleaning the touchscreen .....70  
Clear bypasses.....29  
Clock/calendar .....41, 42

## D

Delete” button ..... 46, 53, 56  
Device activation .....5  
Devices ..... 2, 5, 20, 74, 79  
Dialer test .....68, 69  
Disarm ... 6, 7, 8, 17, 18, 20, 23, 24, 25, 26, 33, 60, 66  
Disarming the system.....26  
Disarming the system and silencing alarms .....26  
Disarming the system during entry delay .....26  
Duress code.....33  
Edit button ..... 46, 53, 54  
E-mail events .....44, 47  
Entering test mode .....68  
Entry delay ..... 6, 17, 18, 20, 23, 24, 25  
Entry exit zones .....18  
Exit alarms .....7, 24  
Exit delay.....24  
Exit time restart-exit delay restart/reset .....7  
Exit/entry delays .....7

## F

False alarm prevention features ..... 7  
False alarms ..... 7, 24  
Features ..... 5  
Fire alarm ..... 11, 27, 30  
Fire alarm system ..... 72  
Fire protection ..... 6

## G

Guest code ..... 17, 18, 20, 33

## H

Home screen..... 10, 13  
Home” (cancel) key ..... 13

## L

LCD display ..... 13  
Light .....59  
Liquid crystal display.....13  
Listen mode.....63  
Location .....13

## M

Manually configure access point .....55  
Master menu .....15  
Master user ..... 6, 33  
Master user code..... 14, 15, 33, 35, 37, 41, 51, 65, 68  
Memory of alarm .....66  
Menu.....13  
Menu screens .....14  
Message center ..... 5, 10, 38  
Microphone .....38  
Mobile devices .....56  
Multi-mode feature .....64

## N

Navigation keys ..... 13  
News .....13  
Night stay mode.....18  
No delay .....23  
Notices .....13

## P

Panic key ..... 5, 30, 72  
Personal emergency/aux. Alarm ..... 30  
Phone control ..... 5  
Preset buttons .....59

## Q

Quick arm ..... 8, 17, 18, 19, 20, 21  
Quick exit .....23

<b>R</b>	
Ready indicator .....	16, 17, 18, 20, 26
Ready LED .....	16
Real-time clock.....	5
Reboot.....	68, 69
Rechargeable, nickel-metal hydride battery pack ..	70
Reminder feature.....	51
Reminders .....	51
Remote access feature .....	64
Remote interactive phone capability .....	62
Remote phone control.....	5, 62
Remote services.....	64
Reset video cameras .....	58
Restart exit delay.....	8
Restarting exit delay .....	24
Return/home.....	59
Rules .....	44, 47

<b>S</b>	
Scan access points.....	54, 56
Schedules.....	5, 44, 45, 46
Schedules feature.....	5, 44
Security .....	13, 26
Security codes .....	5, 6
Security screen.....	23, 28, 29, 31
Servicing information .....	76
Silence alarm .....	26
Silencing a fire/carbon monoxide alarm.....	72
Silencing low battery warning tones .....	70
Silent emergency/silent alarm .....	30
Silent exit .....	21
Slide show .....	65
Smoke detectors .....	6, 69, 70, 72, 73, 79
SMS feature .....	64
Speaker phone.....	5, 10, 60, 67
Status area .....	13
Stay mode.....	6, 17, 23
System battery .....	71
System settings.....	40
System status.....	16

<b>T</b>	
Tablets.....	56
Talk mode .....	63, 68, 69
Test mode.....	68
Time and date.....	14, 41
Touchscreen control .....	5, 10
Traffic .....	13
Two way voice feature (alarm audio verification ..	63
Two-way voice.....	5
Two-way voice feature.....	6

<b>U</b>	
Unrestricted menu .....	14
User access.....	33
User codes .....	5, 33

<b>V</b>	
Video.....	13
Video camera control.....	57, 59
Video camera reset .....	58
Video cameras.....	57
Video function buttons. ....	57
Voice dialog.....	6
Volume level .....	10, 16, 40
VOX (voice) mode .....	63

<b>W</b>	
Walk test.....	68, 69
Weather.....	13, 43
WiFi configuration .....	54
WiFi internet connection .....	57
Wireless keypads .....	5
Wireless sensors .....	70

<b>Z</b>	
Zones .....	5, 6, 16, 28, 29, 66, 69
Z-wave devices .....	44

## **TWO YEAR LIMITED WARRANTY**

Honeywell International Inc., acting through its Security & Communications business ("Seller"), 2 Corporate Center Drive, Melville, New York 11757 warrants its products to be free from defects in materials and workmanship under normal use and service, normal wear and tear excepted, for 24 months from the manufacture date code; provided, however, that in the event the Buyer presents a proper invoice relating to the purchased product and such invoice bears a date later than the manufacture date, then Seller may at its discretion, reflect the warranty period as commencing at invoice date. Except as required by law, this Limited Warranty is only made to Buyer and may not be transferred to any third party. During the applicable warranty period, Seller will repair or replace, at its sole option and as the exclusive remedy hereunder, free of charge, any defective products.

Seller shall have no obligation under this Limited Warranty or otherwise if the product:

- (i) is improperly installed, applied or maintained;
- (ii) installed outside of stated operating parameters, altered or improperly serviced or repaired by anyone other than the Seller/Seller's Authorized Service/Repair Center;
- (iii) damage is caused by outside natural occurrences, such as lightning, power surges, fire, floods, acts of nature, or the like; or
- (iv) defects result from unauthorized modification, misuse, vandalism, alterations of serial numbers, other causes unrelated to defective materials or workmanship, or failures related to batteries of any type used in connection with the products sold hereunder.

**Exceptions to Warranty With Respect to Honeywell Products listed below:**

Hardwire Contacts and PIRs – Seller warrants parts for hardwire contacts and PIRs in accordance with the terms of the above limited warranty for a period of five (5) years from the manufacture date code.

**EXCLUSION OF WARRANTIES, LIMITATION OF LIABILITY**

THERE ARE NO WARRANTIES OR CONDITIONS, EXPRESS OR IMPLIED, OF MERCHANTABILITY, OR FITNESS FOR A PARTICULAR PURPOSE OR OTHERWISE, WHICH EXTEND BEYOND THE DESCRIPTION ON THE FACE HEREOF. TO THE FULLEST EXTENT PERMITTED BY LAW, IN NO CASE SHALL SELLER BE LIABLE TO ANYONE FOR ANY (i) CONSEQUENTIAL, INCIDENTAL, INDIRECT, SPECIAL, OR PUNITIVE DAMAGES ARISING OUT OF OR RELATING IN ANY WAY TO THE PRODUCT AND/OR FOR BREACH OF THIS OR ANY OTHER WARRANTY OR CONDITION, EXPRESS OR IMPLIED, OR UPON ANY OTHER BASIS OF LIABILITY WHATSOEVER, EVEN IF THE LOSS OR DAMAGE IS CAUSED BY SELLER'S OWN NEGLIGENCE OR FAULT AND EVEN IF SELLER HAS BEEN ADVISED OF THE POSSIBILITY OF SUCH LOSSES OR DAMAGES. Any product description (whether in writing or made orally by Seller or Seller's agents), specifications, samples, models, bulletin, drawings, diagrams, engineering sheets or similar materials used in connection with the Buyer's order are for the sole purpose of identifying the Seller's products and shall not be construed as an express warranty or condition. Any suggestions by Seller or Seller's agents regarding use, applications, or suitability of the products shall not be construed as an express warranty or condition unless confirmed to be such in writing by Seller. Seller does not represent that the products it sells may not be compromised or circumvented; that the products will prevent any personal injury or property loss by burglary, robbery, fire or otherwise, or that the products will in all cases provide adequate warning or protection. Buyer understands that a properly installed and maintained alarm may only reduce the risk of a burglary, robbery or fire without warning, but it is not insurance or a guarantee that such will not occur or will not cause or lead to personal injury or property loss. CONSEQUENTLY, SELLER SHALL HAVE NO LIABILITY FOR ANY PERSONAL INJURY, PROPERTY DAMAGE OR OTHER LOSS BASED ON ANY CLAIM AT ALL INCLUDING A CLAIM THE PRODUCT FAILED TO GIVE WARNING. However, if Seller is held liable whether directly or indirectly for any loss or damage with respect to the products it sells, regardless of cause or origin, its maximum liability shall not in any case exceed the purchase price of the product, which shall be fixed as liquidated damages and not as a penalty, and shall be the complete and exclusive remedy against the Seller. Should your product become defective during the warranty, please contact your installer to facilitate repair or replacement with Seller pursuant to the terms hereof. Seller reserves the right to replace any defective product under warranty with new, refurbished, or remanufactured product.

# Honeywell

2 Corporate Center Drive, Suite 100  
P.O. Box 9040, Melville, NY 11747  
Copyright © 2014 Honeywell International Inc.

[www.honeywell.com/security](http://www.honeywell.com/security)



800-16083V1 12/14 Rev. A